

# Installation Instruction User Guides



## SE-TX 01

Safety edge transmitter junction box kit

# I. Description

## 1.1 Overview

In the modern era, multifunctional safety devices have become an indispensable part of ensuring safety. This device features a safety edge port capable of integrating with an 8.2K electrical safety edge, or optical edge sensors kit. Additionally, it is equipped with slack rope switch detection port and various other safety equipment, offering comprehensive safety protection. The versatility of this safety device allows it to play a crucial role in homes, industries, and public spaces. Its ability to connect with multiple types of safety equipment ensures a high level of security and peace of mind across different environments.

## 1.2 Features and Advantages

**Real-time monitoring:** Real-time monitoring of various connected safety devices to provide comprehensive safety protection.

**Automatic trigger function:** When an abnormal situation is detected, the corresponding safety measures are automatically triggered to achieve real-time safety protection.

**Simple installation:** The design is compatible with wireless installation in multiple scenarios, making the installation process simple and quick, saving both time and cost.

## 1.3 Scenarios of Use

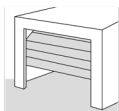

Sectional doors

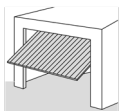

Tilting doors

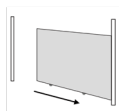

Sliding gates

# II. Features and Technical Data

## 2.1 Features

- Trio-Frequency technology for anti-interference
- Signal range (normal): 20 meters
- Various safety mode options
- Power supply: One 3.6V lithium battery.
- Approximate battery life of 2 years.
- Operating temperature: -20°C - + 60°C

## 2.2 Technical Data

|  |   |
|--|---|
| Model                                    | SE-TX 01                                  |
| Radio technology                         | Trio-Frequency technology                 |
| Frequency                                | Multi from 409.025 MHz – 458.4 MHz        |
| Signal modulation                        | FSK                                       |
| Signal range                             | 20 meters                                 |
| Power supply                             | 3.6V DC ( 3.6V lithium battery)           |
| Channels                                 | 2 channels ( Reversal & Stop per channel) |
| Battery capacity                         | 2600 mAh                                  |
| Current of different safety margin modes | Optical edge sensor 9mA<br>8.2K 4.2mA     |
| Standby                                  | 70 ua                                     |
| IP grade                                 | IP 65                                     |
| Operating temperature                    | -20°C - + 60°C                            |

## III. Product Composition Display

### 3.1 Introduction to Components

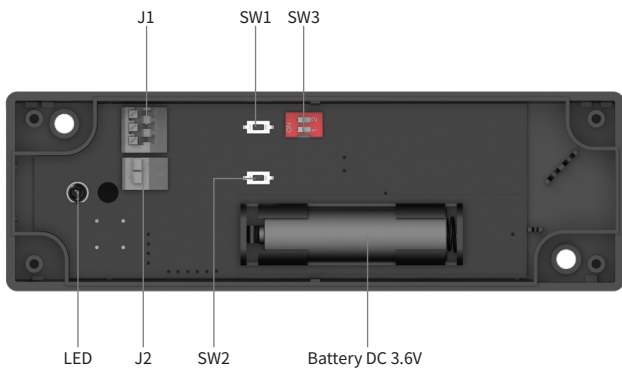
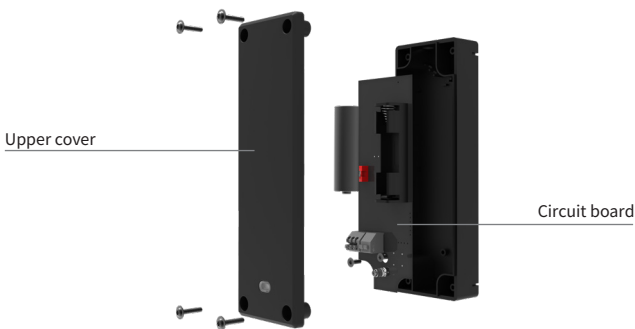

SW1: Wireless pairing button

SW2: Pairing button for slack rope switch

SW3: Dip switch for different safety devices, SW3-DP1 and SW3-DP2, Switch for optical edge sensor or 8.2k safety edge.

J1: Wiring port for safety edge device

J2: Wiring port for slack rope switch

LED: Green light for safety edge devices trigger; Red light for slack rope switch trigger

Battery:

Model: 14505,

Voltage: DC 3.6V

Capacity: 2600mah lithium-ion battery.

Note: Do not use batteries with other voltage and capacity instead.

## Safety edge type selection

|                     | SW3-DP1 | SW3-DP2 |
|---------------------|---------|---------|
| Optical edge sensor | OFF     | OFF     |
| 8.2K resistor       | ON      | OFF     |



**Note:** Each time you switch the safety edge type, please make sure the battery has been removed before using the DIP switch to make a selection, otherwise the switch will be invalid.

## IV. Installation and Configuration

### 4.1 Tools

In order to quickly and safely install the junction box, the following tools are recommended:



Pistol drill



Tape measure



Screwdriver



Pencil

### 4.2 Installation Steps and Operating Instructions

4.2.1 Before installation, first perform a PAIRING TEST to ensure that the product functions normally and avoid the inconvenience of code matching after installation.

-- Step Instructions:

A. Open the housing component, use a screwdriver to open the cover, and install the appropriate battery.

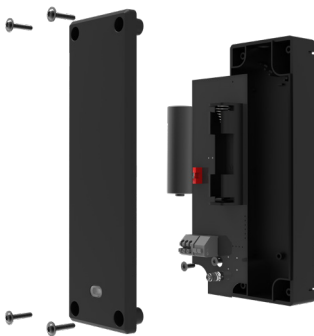

B. Find the  button on the motor you are pairing and press it for 3 seconds until the LED indicator lights up, signaling that it has entered pairing mode. Press and hold the Wireless Safety Junction Box pairing button until the LED light of the motor you are pairing flashes quickly. Check that the corresponding indicator lights up to indicate successful pairing (For detailed device pairing information, see the QR code on the last page of this manual).

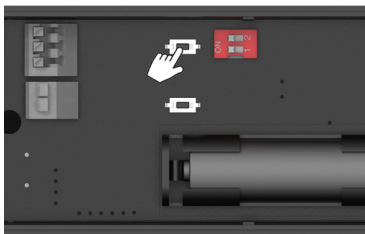

Pairing Button for Safety Edge

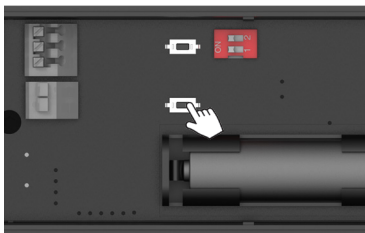

Pairing Button for Slack rope switch

### C. Wiring Diagram

Optical edge sensor

SW3-DP1:OFF SW3-DP2:OFF

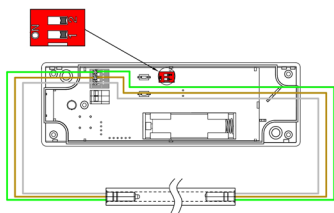

8.2K resistor

SW3-DP1:ON SW3-DP2:OFF

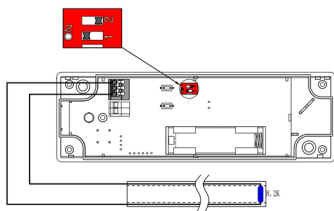

### Slack Rope Switch

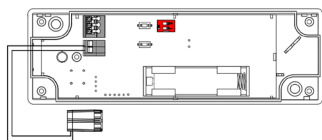

D. When the door is closing and meeting obstacle, the green LED light of safety edge port will light up, and check whether the door is reversed to open limit position.

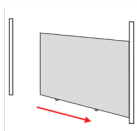
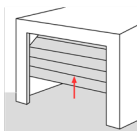

E. When the door is running and steel rope on drum is loose, the red LED light of slack rope switch port will light up, and check whether the door is stopped.

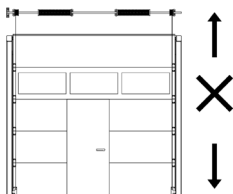

## 4.2.2 Installation instruction

According to position of the door, suggested installation position is 10-15cm from ground and 10-15cm from door track.

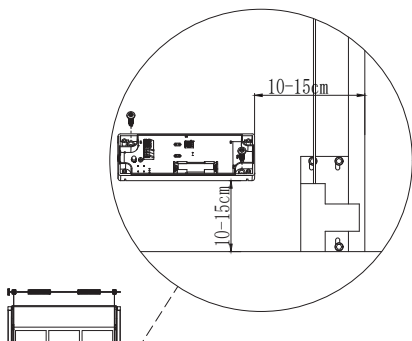

## 4.3 Setting and adjustment test

During door closing, trigger safety edge rubber seal, door will reverse and open.

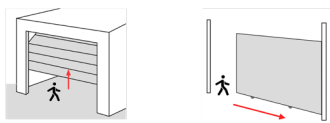

**Note:** If the door can not work same as above instruction, please check again from step B and Step C in 4.2.1 and finish the test.

4.4 After test is completed, install the upper cover of the safety edge transmitter junction box kit.

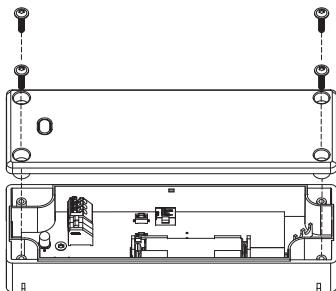

## V. Service Devices

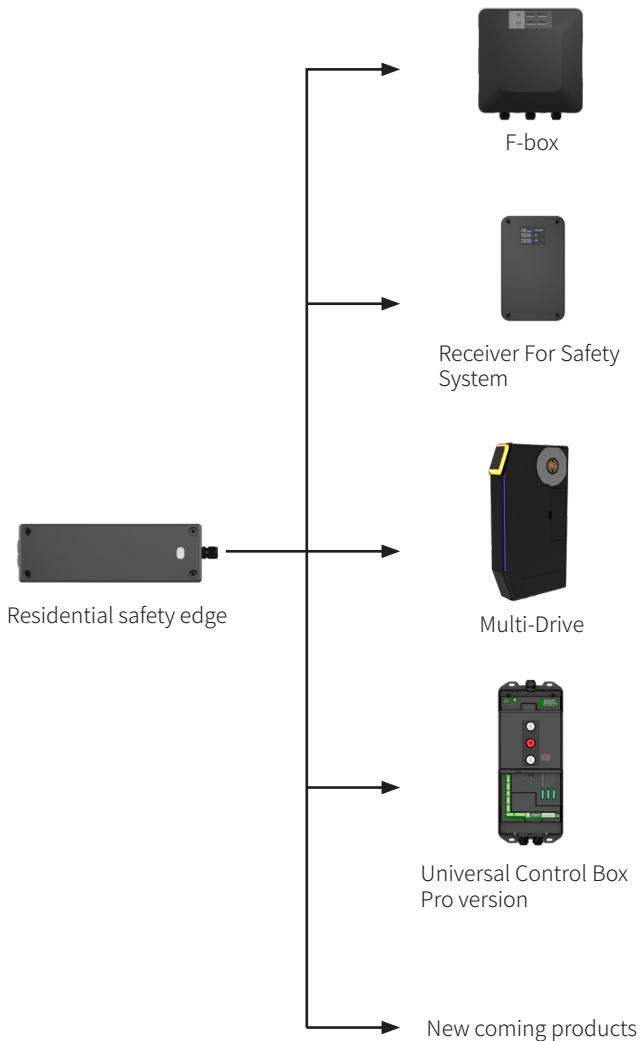



# VI. Appendix

## 6.1 Dimensions

Unit of Length: mm

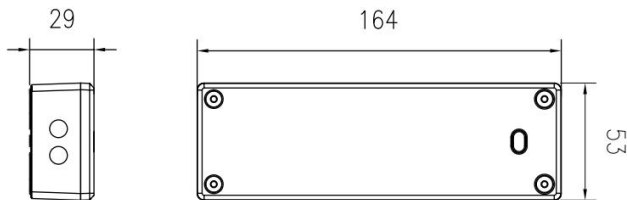

Note:

### 1. Low Battery Alarm:

If battery in safety edge transmitter junction box kit is low, please check your paired device promptly.

Warning can be in 2 ways: SOUND warning or COURTESY LIGHT warning (For details, please refer to the corresponding instructions)

### 2. Battery Depletion:

If the battery is too low, when only safety edge sensor is paired, the motor can open the door but cannot close the door.

When both safety edge sensor and slack rope switch are paired, the motor cannot work at all.

### 3. Deleting Wireless Devices:

To delete a wireless device, long press the  button on your paired motor/device for more than 8s, until the paired device's wireless light turns off, all wireless safety devices paired with the motor/device will be deleted.

If need to reconfigure, need to pair one by one again. (For details, please refer to the corresponding instructions).

### 4. Replace battery:

Please use the corresponding tool, open the cover of the device and replace the 14505 Lithium sub-battery.

Notice: Voltage: DC 3.6V, Capacity: 2600mah.

## 6.2 Accessories List

### Optical edge sensor set

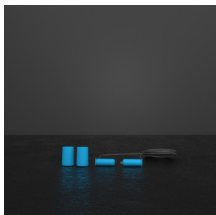

### Optical edge sensor set Specification

- Universal optoelectronic safety edge
- Suitable for radio modules/spiral cables
- Automatic operating mode recognition radio modules/spiral cable
- Larger door width possible
- High electromagnetic interference immunity
- Resistant against voltage reversal and short-circuits
- Regulated transmit power
- OSE-signal
- Compatible with all common door controls
- Degree of protection IP67, filled with epoxy resin

### Optical edge sensor set Technical data

|                                    |   |
|------------------------------------|---|
| Operating voltage                  | 2.8V---12V  |
| Current consumption                | 3.4mA---4.6mA                                       |
| Voltage and transmission frequency | < 7V--- frequency: 400Hz<br>> 7V--- frequency: 1KHz |
| Housing material                   | Plastic ABS, Lexan, IR transparent                  |
| Wire material                      | PUR, halogen free, acid- and oil-resistant          |
| Wire length                        | TX 6m + RX1m & TX10m + RX1m                         |
| IP grade                           | IP 67   |
| Operating temperature              | -20°C - +70 °C                                      |

The safety edge transmitter junction box kit also can realize the motor control extension function.

If you want to trigger the motor through an external device:

During the closing process of the door, trigger the external device, and the motor will open the door.

For example, you can build a scene by using relays, micro switches, ground sensors, photo beam devices, etc.

The jumper cap selection is as shown in the figure. The dip switch selects 8.2K mode.

DP1:ON DP2:OFF

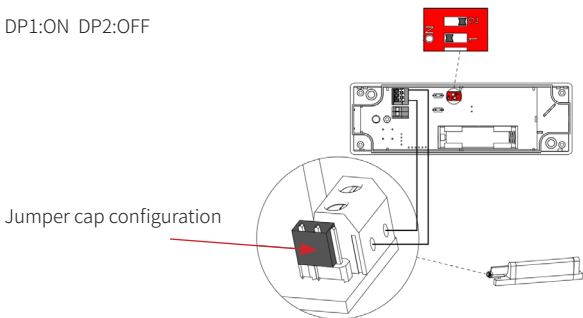

If you want to trigger the motor through an external device:

During the closing process of the door, trigger the external device, and the motor will stop the door.

For example, you can build a scene by using relays, micro switches, ground sensors, photo beam devices, etc.

When you need to stop the door by safety junction box

The jumper cap selection is as shown in the figure.

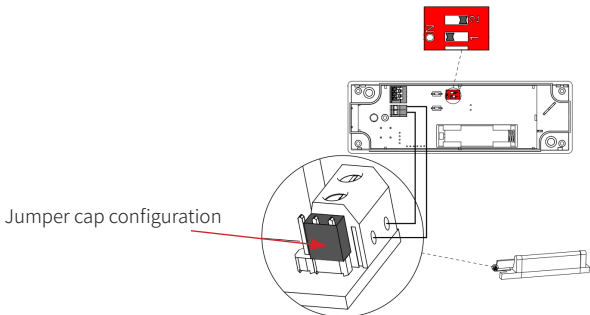

## Detailed Instructions for Coding with Related Devices

