

Garage Door Opener

Control System Instructions And User Guide

S/N	
-----	--

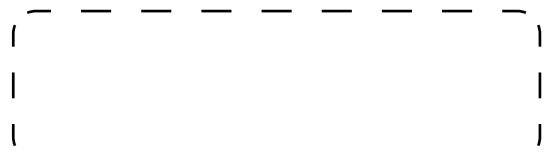

Table Of Contents

1. Critical Safety Guidelines 01

2. Button/Coin Cell Battery Safety 02

3. Product Overview & Features 03

4. Technical Specifications 04

5. Port Wiring Configurations 06

6. Basic button instructions 07

7. Quick setting instructions 08

8. F-LinX APP Configuration 09

9. Wireless device code pairing and clearing instructions 11

10. Wireless device light description 14

11. Parameter overview 15

Table Of Contents

12. Parameter details	17
-----------------------	----

13. Running display codes	37
---------------------------	----

14. Common fault & solutions	38
------------------------------	----

1. CRITICAL SAFETY GUIDELINES

Failure to comply with these instructions may result in severe injury, death, or property damage.

1. Read and adhere to all safety and installation guidelines.

2. Installation Compliance:

- The opener complies with regional safety standards. Installers must verify alignment with local regulations.
- Only qualified personnel familiar with occupational health and safety standards for automated doors may perform installations.

3. Safety Responsibility:

- Installers/service providers failing to adhere to standards assume full liability for damages or injuries.

4. Photoelectric Sensor Recommendation:

- While the opener includes a pressure-sensitive safety system, installing a photoelectric sensor (Photo Beam) is strongly advised to enhance obstruction detection.

5. Operational Precautions:

- Ensure the door is fully stationary before entering/exiting the garage.
- Keep hands and loose clothing clear of moving components.

6. Safety Obstruction System Limitation:

- Designed for stationary objects only. Contact with moving objects may cause failure.

7. User Restrictions:

- Not intended for unsupervised use by children or individuals with reduced physical/mental capabilities.

8. Disposal:

- Dispose of electrical waste via certified recycling facilities.

9. Power Cord Safety:

- A damaged supply cord must be replaced by the manufacturer or certified personnel.

10. Monthly Safety Checks:

- Verify door reversal upon contacting a 50mm obstruction. Adjust if necessary.
- Inspect cables, springs, and mountings for wear/tear monthly.

11. Manual Release Warning:

- Exercise caution during manual release to prevent rapid door descent caused by spring failure.

12. Maintenance Protocol:

- Disconnect power before cleaning or servicing.

2. BUTTON/COIN CELL BATTERY SAFETY

1. WARNING:

- Contains a button/coin cell battery (lithium CR2032 or equivalent).
- Keep batteries out of reach of children. Ingestion may cause fatal injuries within 2 hours.
- Seek immediate medical attention if swallowed.

2. Transmitter Battery Replacement:

- Step 1: Remove screws on the transmitter's underside.
- Step 2: Replace battery with an identical specification (e.g., CR2032).
- Step 3: Verify red indicator illumination after reassembly.

3. PRODUCT OVERVIEW & FEATURES

Feature	Description
1. Adjustable Obstruction Force	Levels 1 (min) to 5 (max).
2. Travel Speed Adjustment	80% speed ("8") or full speed ("A": 160–200mm/s).
3. Reversal Time Setting	0 = rebound to top; 1–9 = reverse duration (1–9 seconds).
4. Partial Open Height	0 = disabled; 1–C = preset heights.
5. Transmitter Button Recognition	0 = all buttons active; 1 = single-button control.
6. Soft Stop Adjustment	Levels 1 (short) to 3 (long). Default: Level 2 (medium).
7. Maintenance Alarm	LED flashes 10× to signal required maintenance.
8. Auto-Reverse Safety	Software-controlled reversal upon obstruction detection.
9. Soft Start/Stop	Reduces mechanical stress and noise.
10. Auto-Close	Activates after user entry/exit for security.

4. TECHNICAL SPECIFICATIONS

Model	FS 600	FS 1000	FS 1200
Input voltage	220 - 240V / 50-60 Hz		
Max. pull force	600 N	1000 N	1200 N
Max. door area	10 m ²	15 m ²	18 m ²
Max. door weight (Balanced)	100 kg	150 kg	180kg
Max. door height	2400 - 3500mm	2400 - 3500mm	2400 - 3500mm
Drive mechanism	Chain / Belt	Chain / Belt	Chain / Belt
Opening / Closing speed	160mm / Second - C Rail		
L.E.D supply voltage (DC)	24V		
Limit setting	Electronic	Electronic	Electronic
Transformer	Overload protection technology		
Radio frequency	433.92 / 868.35 MHz		
Coding format	Rolling code (7.38 x 10 ¹⁹ Combinations)		
Status display transmitter	2 X	2 X	2 X
Code storage capacity	50 different codes (Subject to the actual)		
Caution light terminal	Included	Included	Included
Working temperature	-20°C - +60°C	-20°C - +60°C	-20°C - +60°C
Safety protection	Soft start & Soft stop, Photo cell option, Caution light option		
Protection level	IP20	IP20	IP20

FS 600

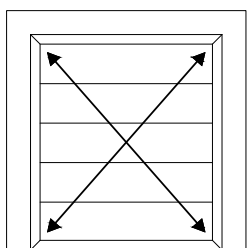

Rated door area: ≤ 10 m²

FS 1000

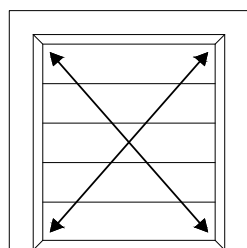

Rated door area: ≤ 15 m²

FS 1200

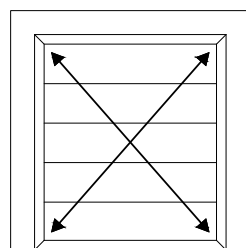

Rated door area: ≤ 18 m²

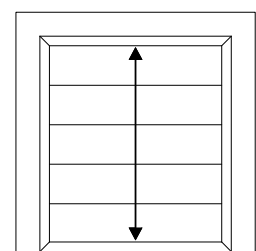

Standard door height: 2400mm
Maximum door height: 3500mm

Model	FS 600-Speed	FS 1000-Speed
Input voltage	220 - 240V / 50-60 Hz	
Max. pull force	600 N	1000 N
Max. door area	8 m ²	12 m ²
Max. door weight (Balanced)	80 kg	120 kg
Max. door height	2400 - 3500mm	2400 - 3500mm
Drive mechanism	Chain / Belt	Chain / Belt
Opening / Closing speed	200mm / Second	200mm / Second
L.E.D supply voltage (DC)	24V	
Limit setting	Electronic	Electronic
Transformer	Overload protection technology	
Radio frequency	433.92 / 868.35 MHz	
Coding format	Rolling code (7.38 x 10 ¹⁹ Combinations)	
Status display transmitter	2 X	2 X
Code storage capacity	50 different codes (Subject to the actual)	
Caution light terminal	Included	Included
Working temperature	-20°C - +60°C	-20°C - +60°C
Safety protection	Soft start & Soft stop, Photo cell option, Caution light option	
Protection level	IP20	IP20

FS 600-Speed

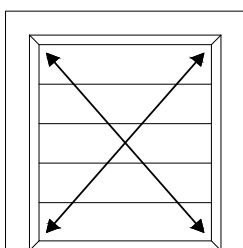

Rated door area: ≤ 8 m²

FS 1000-Speed

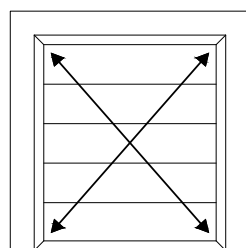

Rated door area: ≤ 12 m²

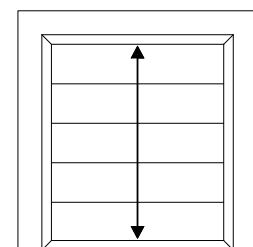

Standard door height: 2400mm
Maximum door height: 3500mm

5. PORT WIRING CONFIGURATIONS

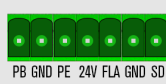
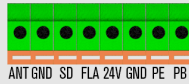

The garage door opener has above types of wiring ports. Please check your motor to find the corresponding port and wire it according to the diagram.

Wired E-Lock (Optional)

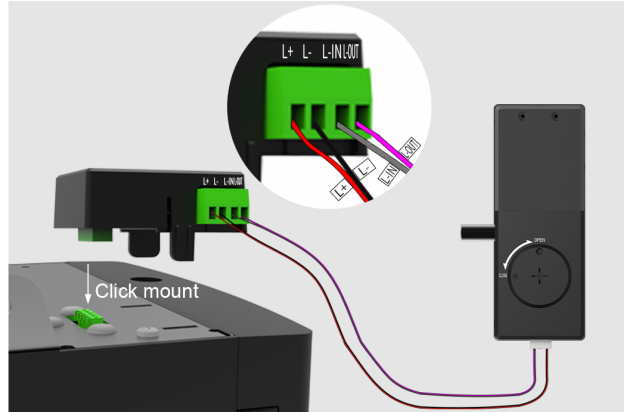

Connect the four wires of the wired E-Lock to the corresponding ports of the E-Lock external device:

- Red: L+
- Black: L-
- Gray: L-IN
- Pink: L-OUT

Click mount the relay module to the connection port of the GDO.

Camera (Optional)

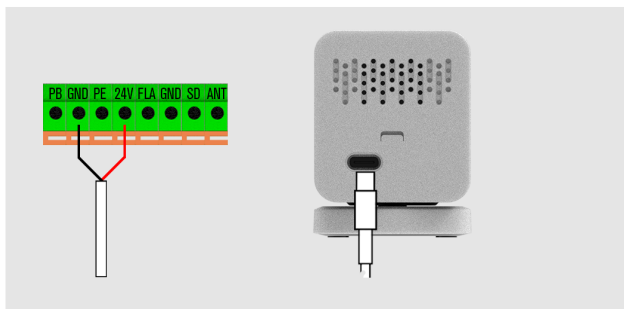

Power connection from camera to opener

Universal receiver (Optional)

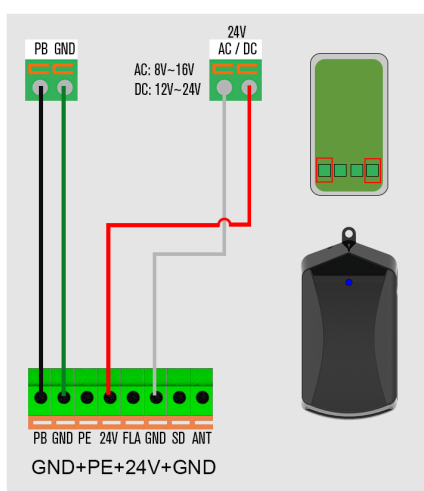

Notice:
Special attention to the wiring.
Cable in red color should be always go to 24V port on garage door opener.
In case of wrong wiring, there may cause damage to the receiver, or even other connected devices.

Wired Photo Cell (Optional)

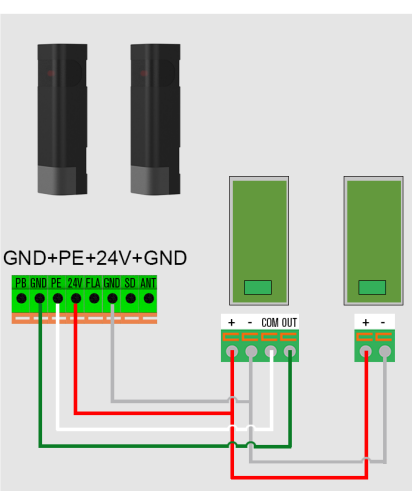

Notice:
Please ensure installation distance between 2 sensors is over 1 meter, otherwise garage door motor can not work properly
Remark:
1. When garage door opener is also connected with a Falsh Light, the power of light should be lower than 10W, otherwise photocell can't work properly due to low power supply.
2. PB (External Push Button) port should be with "NO" contact.



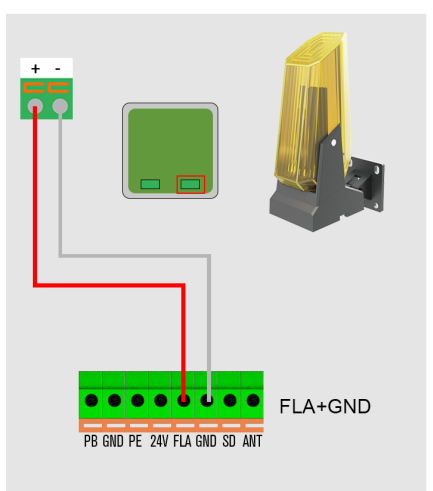

Flash lamp (Optional)











Terminals provide 24-35v flash light voltage.

Connect the flash light with DC 24v-28v, current≤ 100mA. When use AC 220V power flash lights, please match an adapter, and wiring as required.

6. BASIC BUTTON INSTRUCTIONS

Item	Button	Function Description
1.		Short press: Confirm setting. Long press: Enter the function menu setting.
2.		Short press: Remote coding. Long press: Clear the coded remote.
3.		Short press: Open the door. Long press: Increase the over load mode force during closing.
4.		Short press: Close the door. Long press: Restore factory settings.
5.		Long press for 3 seconds: Wireless accessories coding. Long press for 8 seconds: Wireless accessories clearing.

7. QUICK SETTING INSTRUCTIONS

Quick Setup Function	Operation	Function Description
Over load mode	<p>Long press for 4 seconds</p> 	<p>Press and hold the UP button for 4 seconds. The digital display will increment and cyclically show levels 0-3. Release the button to select the current level.</p> <p>0: means the function is disabled (default) 1: increase the overload force 25% based on your current force. 2: increase the overload force 50% based on your current force. 3: increase the overload force 75% based on your current force.</p>
Restore factory settings	<p>Long press for 4 seconds</p> 	<p>Keep press DOWN button, after 4 seconds, it will scroll to display  , then the garage door opener will restart.</p> <p>PS: Restart means all settings are back to factory settings, all learning things need to be done again except the transmitter learning code.</p>
Remote coding	<p>Short press</p> 	<p>1. In the Setting Status, short press CODE, it will exit the current operation and return to the standby interface.</p> <p>2. In the Standby Status, short press the CODE, A dot will be indicated in the corner, now entering the code leaning mode. Now first click the button on the hand transmitter you want to use, the dot may disappear ,then press again the same button on the hand transmitter, the dot will flash, here, the code learning is finished.</p>
Remote clearing	<p>Long press</p> 	<p>Press and hold CODE button until a letter  is indicated on the display.</p> <p>All stored remotes will be deleted.</p> <p>Note: Clearing the remote will not clear all paired wireless accessories.</p>
Coding button for wireless accessories	<p>Long press for 3 seconds</p> 	<p>Enter the wireless device pairing state, the indicator light is always white, and the display  .</p>
Clearing button for wireless accessories	<p>Long press for 8 seconds</p> 	<p>Clear all wireless paired devices, and release the button when the indicator light flashes red.</p>

8. F-LinX APP CONFIGURATION

1. Download the app and follow the prompts to complete the F-LinX app network configuration.



F-LinX APP



IOS



GOOGLE PLAY

2. By scanning the QR code on the body of the motor through the APP, you can quickly get the motor linked to F-LinX app.(QR code on the motor as the photo below)

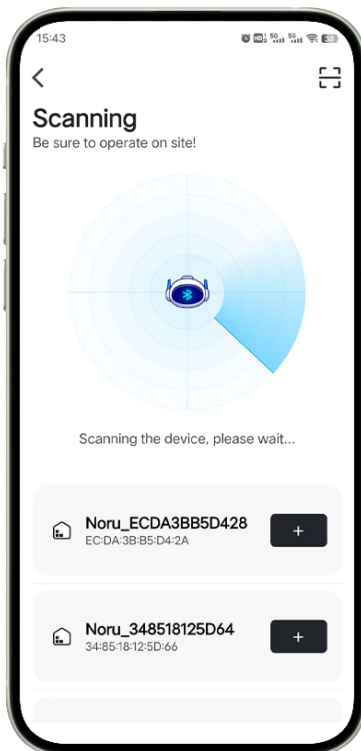

3. With the security center of the F-LinX app, you can monitor and manage your wireless security devices anytime and anywhere, ensuring the safety of your doors without worry. and you can also control it through the app.

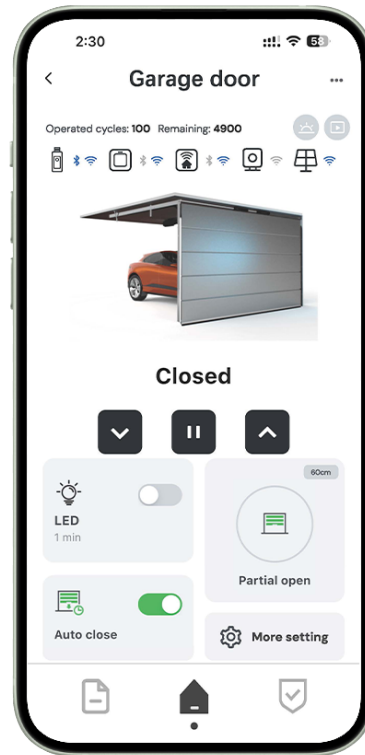
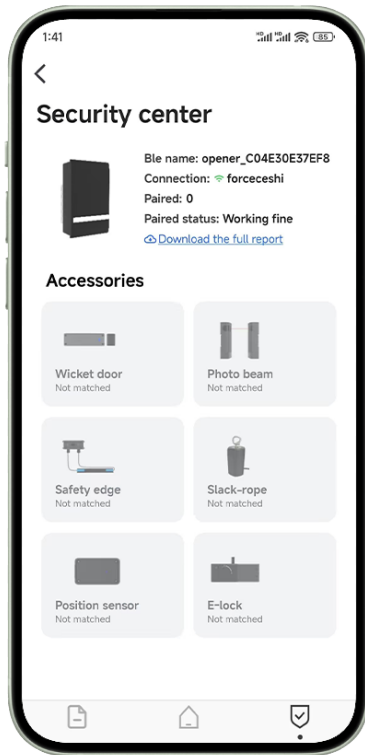

9. WIRELESS DEVICE CODE PAIRING AND CLEARING INSTRUCTIONS

Wireless device code pairing steps

1. Press and hold the wireless devices coding button ON MOTOR for 3 seconds.
2. Check if the LED light is on and the panel display , it means now the motor is in pairing mode.

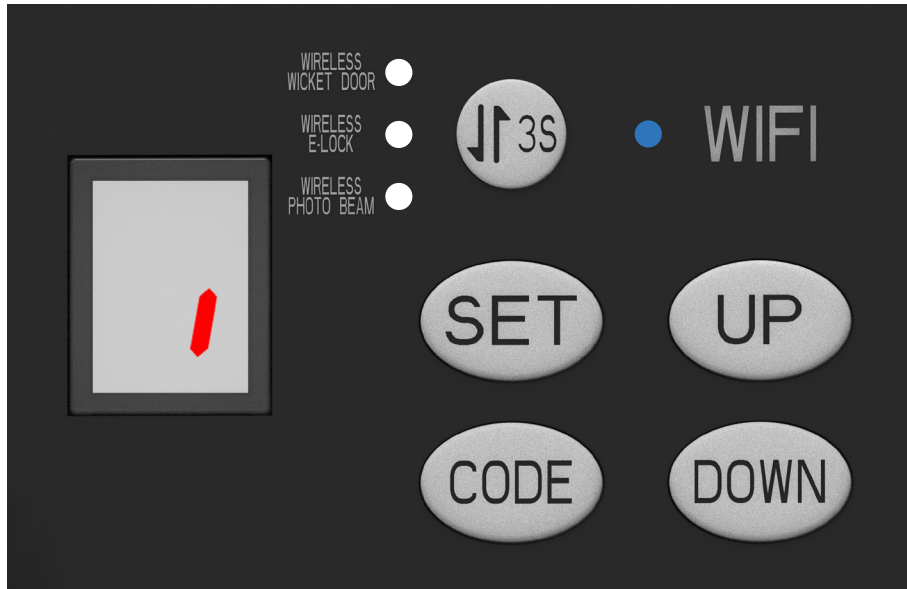

3. Press and hold the pairing button on the wireless device.

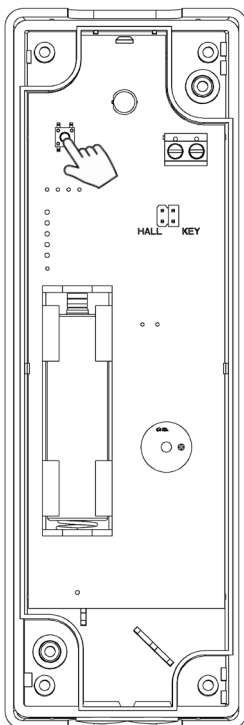

Wireless wicket door
(Optional)

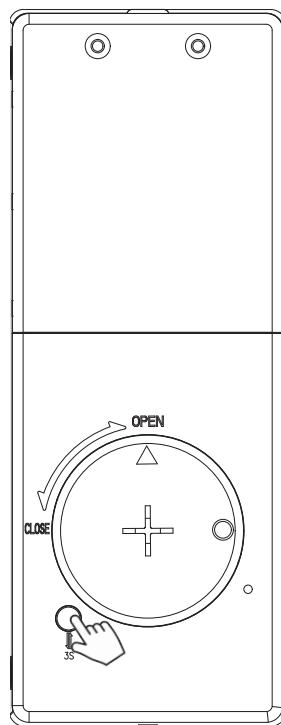

Wireless E-Lock
(Optional)

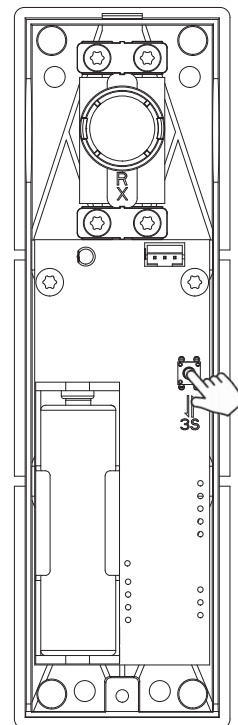

Wireless photo beam
(Optional)

4. After the LED light on the motor flashes, check if the corresponding indicator light is on. (The indicator light color changes according to the device status.)

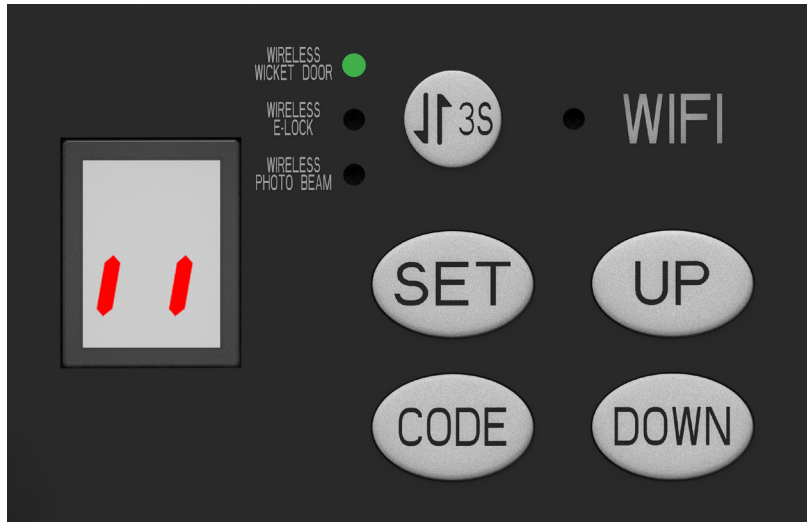

Wireless wicket door

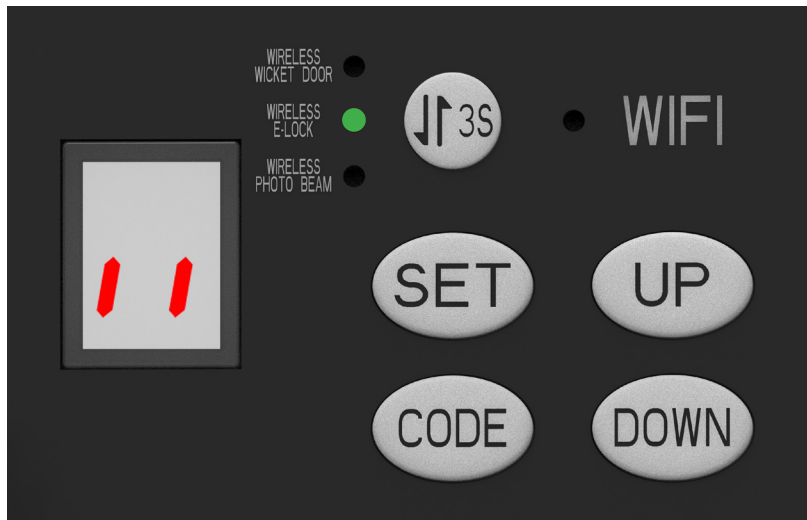

Wireless E-Lock

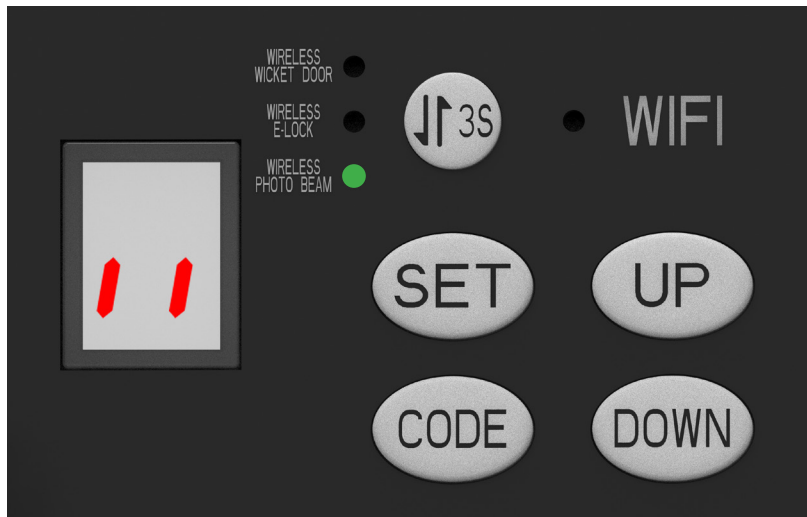

Wireless photo beam

Wireless device code clearing steps

1. Press and hold the wireless pairing button on the motor for 10 seconds.

The motor display . At the same time, the LED light flashes red and blue alternately, and all wireless device indicators turn off after releasing.

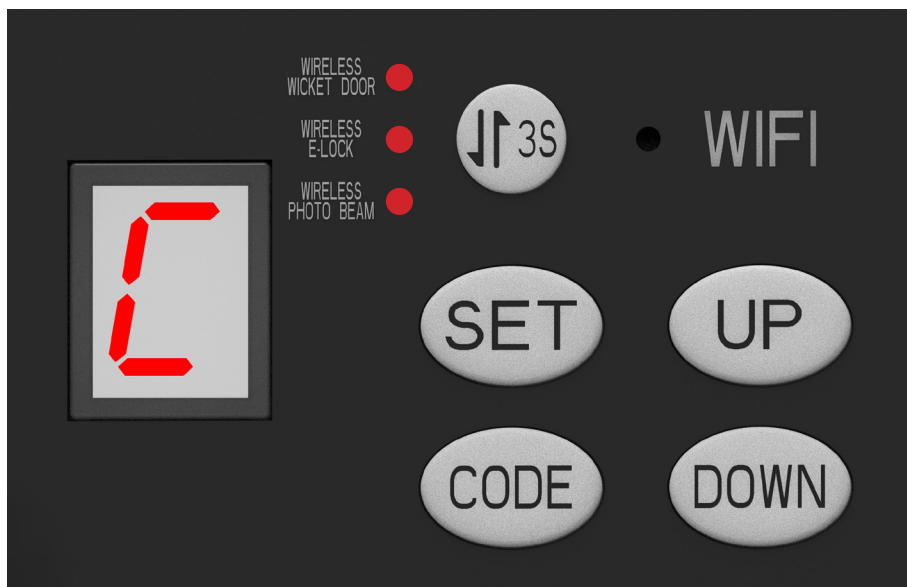





10. WIRELESS DEVICE LIGHT DESCRIPTION

1. The following figure is a reference for the LED color display











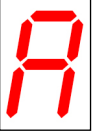
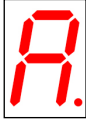



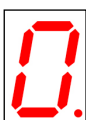

2. Wireless security device status corresponds to different colors of LED display:

LED Color Device Name	 Red	 Green	 Cyan	 Purple	 White
Wireless Wicket Door	Device is paired and triggered	Device is paired and not triggered	Low battery, Device is not triggered	Low battery, Device is triggered	Device signal lost
Wireless E-LOCK	Device is paired and triggered	Device is paired and not triggered	Low battery, Device is not triggered	Low battery, Device is triggered	Device signal lost
Wireless Photo Beam	Device is paired and triggered	Device is paired and not triggered	Low battery, Device is not triggered	Low battery, Device is triggered	Device signal lost

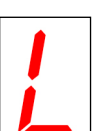
11. PARAMETER OVERVIEW

Par	Function Description	Description of default parameters	P.
	Motor Forward / Reverse rotation adjustment	 : Motor forward rotation (Default)	17
	Programming open & close limits	Learning the door open limit and close limit.	18
	Obstruction force adjustment	 : Obstruction force level 3(Default)	19
	Closing speed setting	 : Full speed (Default)	20
	Auto closing on/off & Auto closing countdown time setting.	 : Auto closing function is not enabled (Default)	21
	Auto closing trigger condition setting (Door position)	 : Auto closing is only triggered when the door is at the open limit (Default)	22
	Led off delay time setting	 : LED light turns off after a 3-minute delay(Default)	23
	Reversal running time setting (After the resistance rebound)	 : Full open running to the open limit after resistance rebound	24
	Partial open function ON/OFF & Partial open height setting	 : The Partial open function is not enabled (Default)	25
	Transmitter buttons recognition function setting	 : The transmitter button recognition is under single key cycle model (Default)	27

Par	Function Description	Description of default parameters	P.
	Soft stop distance adjustment	 : Short range of soft stop distance (Default)	28
	Reversal position ignoring setting while obstruction	 : Reversal position ignoring setting to 1cm up the ground (Default)	29
	Wired pass door sensor port setting (NO/NC)	 : Normally Open (NO) port for pass door sensor (Default)	30
	Wired photo beam function ON/OFF	 : Photo beam function is not enabled (Default)	31
	Maintenance alarm operation cycles count setting	 : Maintenance alarm function is not enabled	32
	Community function (Parking lot function) ON/OFF	 : Community function (Parking lot function) is not enabled (Default)	34
	Opening force adjustment setting	 : Opening force under normal level 5 (Default)	35
	Wired E-Lock function ON/OFF	 : Wired E-Lock function is not enabled (Default)	36

12.PARAMETER DETAILS

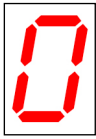

: Programming Motor Forward / Reversal rotation.

① This function is applicable to swing doors. When enabled, the trolley moves forward during door opening and backward during closing.

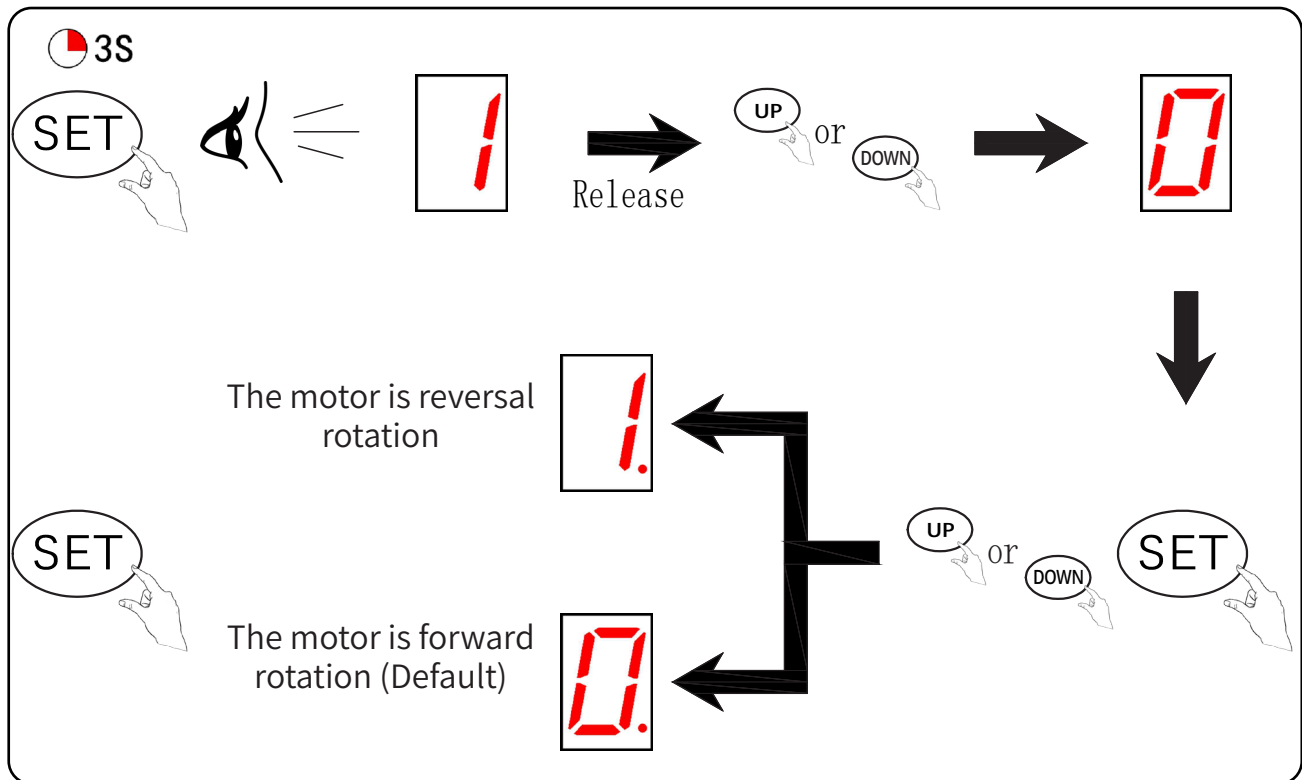

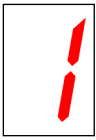

Parameter: Programming Open & Close Limits

① Pre-Setup Preparation: Manually open the door to half-height to avoid incorrect rotation during setup. Entering the travel limit menu will clear previous settings.

① Motor Direction Verification: Confirm motor output direction aligns with door movement

1. Enter travel limit setting

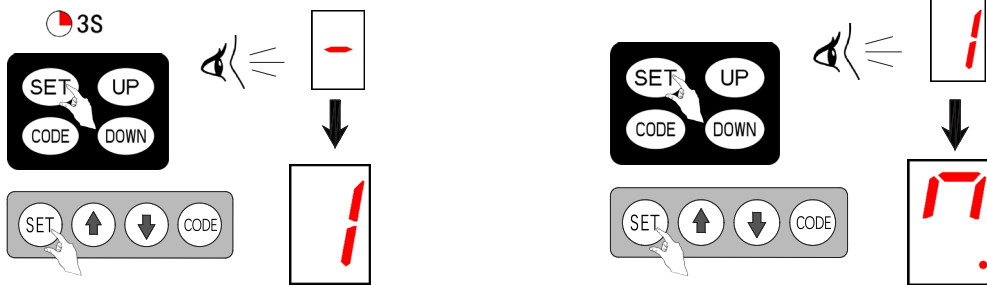

2. Check the direction of motor output and the door running operation

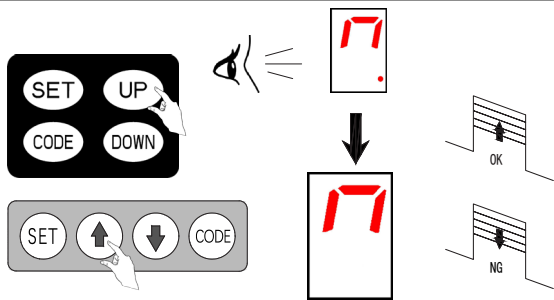

Note: If the motor running direction does not match the door running direction, please exit the learning process first and adjust the motor running direction in the 0 menu.

3. Start the travel limit set, open the door and move the door to the open limit position

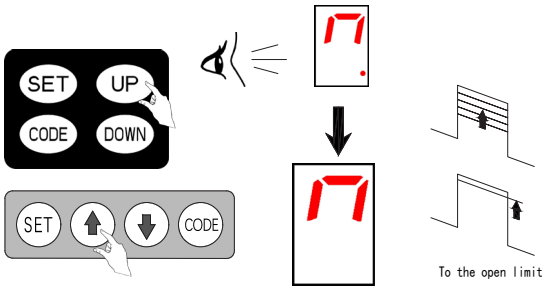

4. Save open limit position

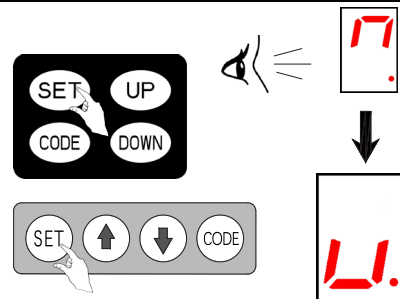

5. Close the door and move the door to the close limit.

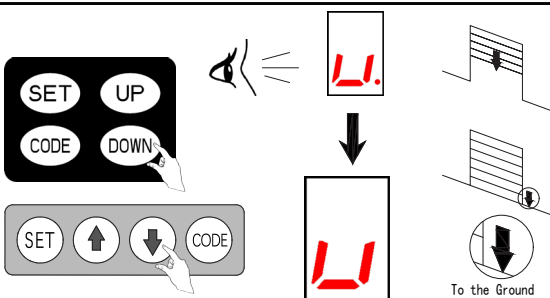

6. After confirming the close limit position, the motor enters into self-learning. When the motor self-learning is complete, the travel limit set is complete.

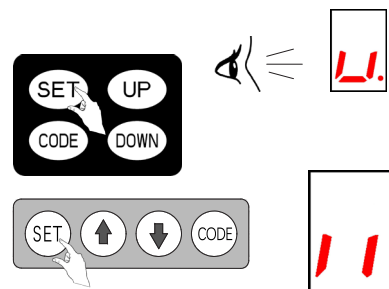



Parameter: Obstruction Force Adjustment

① **Note:**

Automatically configured during initial setup. Manual adjustment is unnecessary normally.

① **Default:** Level 3 (Medium force).

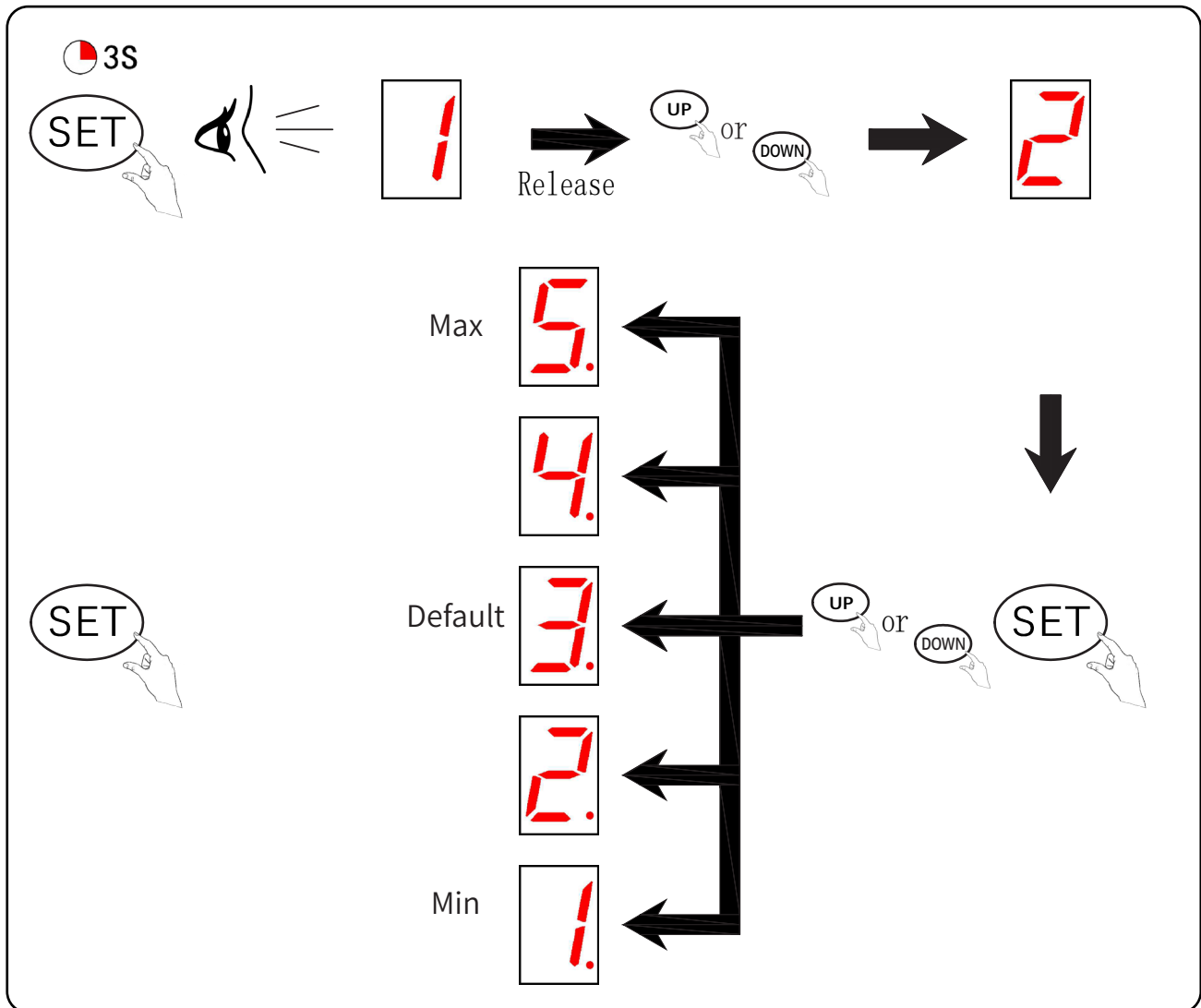



Parameter: Closing Speed Setting

Note:
Adjusts closing speed only.

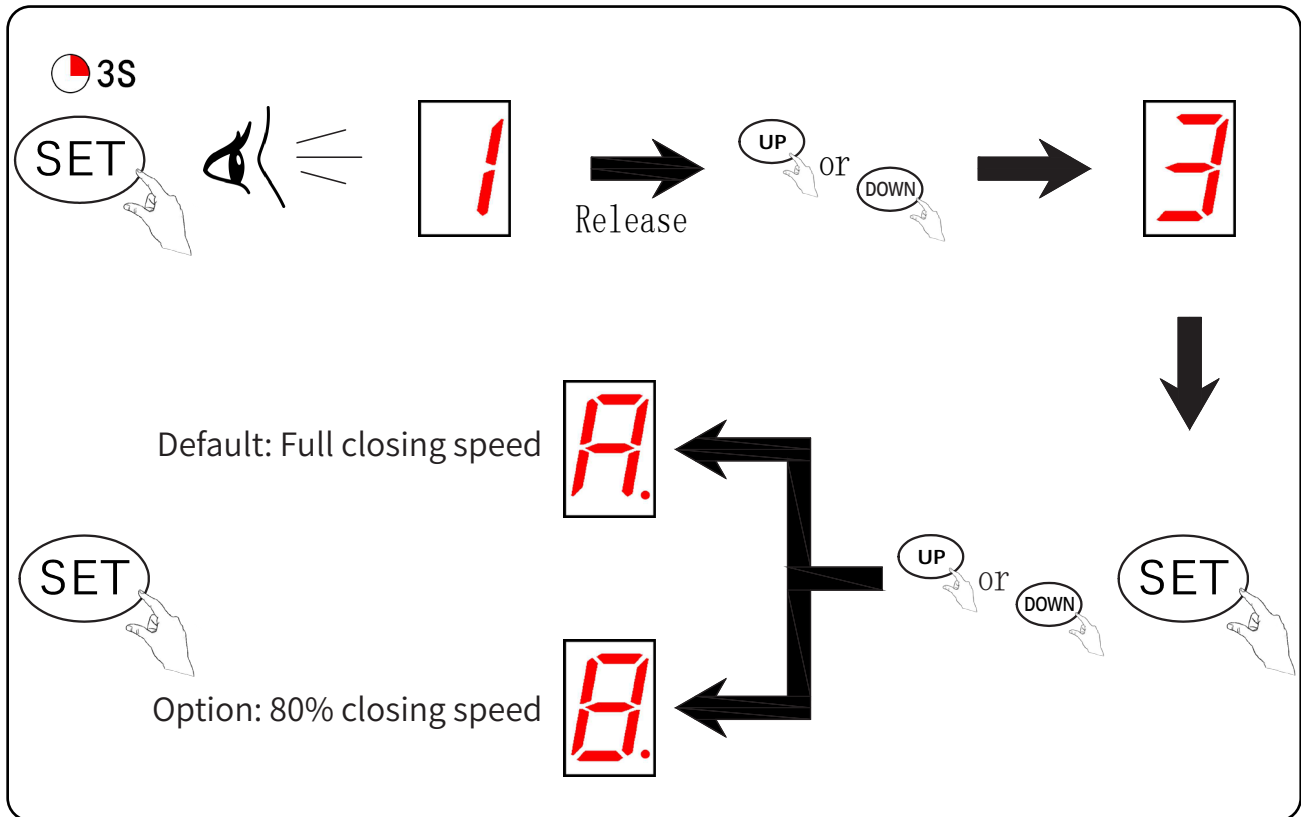

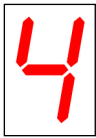

: Auto closing on/off & Auto closing countdown time setting.

- ① Range: 1–135 seconds (9 intervals).
- ① Prerequisite: Photo beam function must be enabled.
- ① Behavior: Obstructions pause the timer, which resumes after clearance.

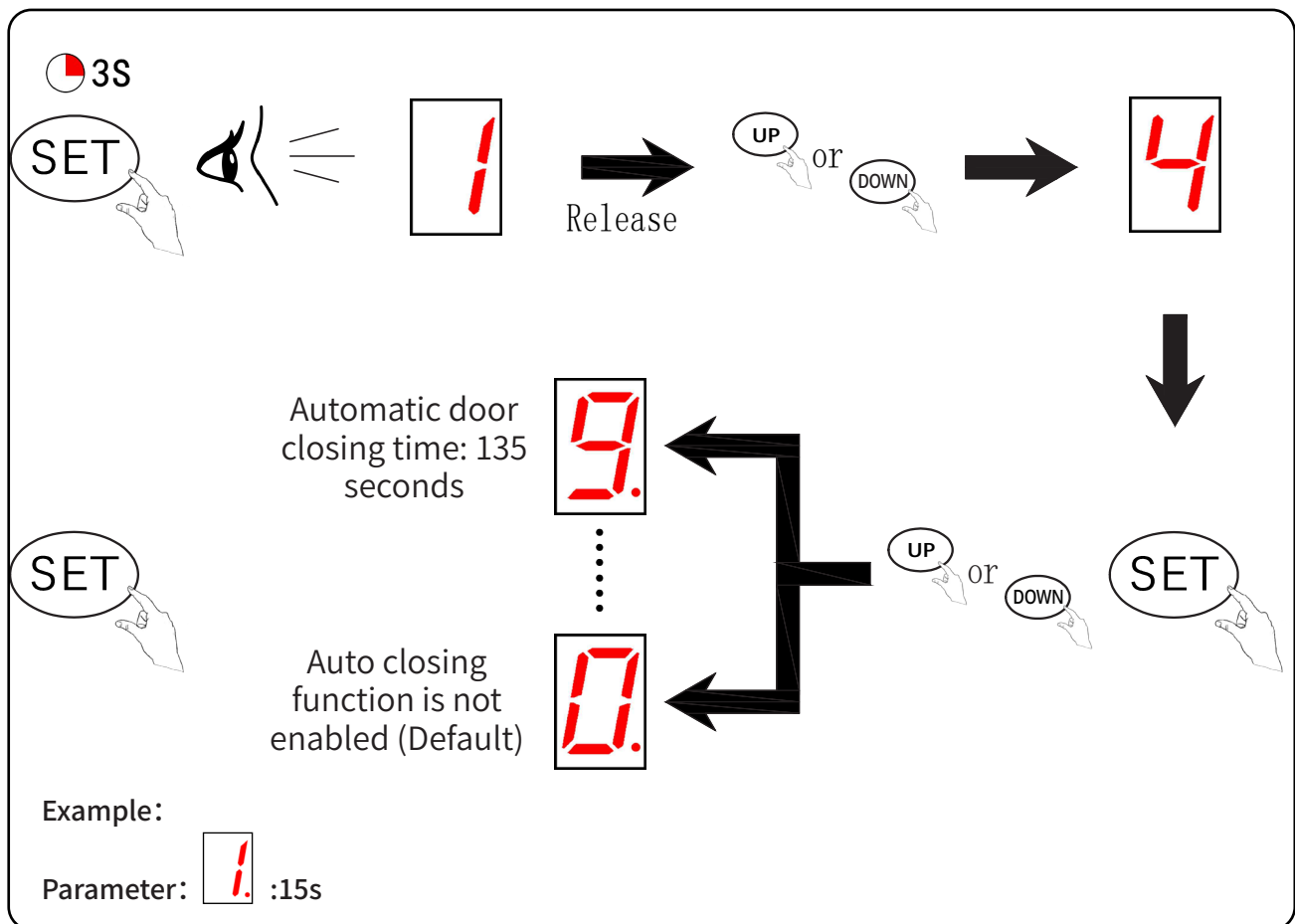



: Auto closing trigger condition setting (Door position)

① Default: Door closes only from the fully open limit position.

② Alternative: Door closes from any intermediate position

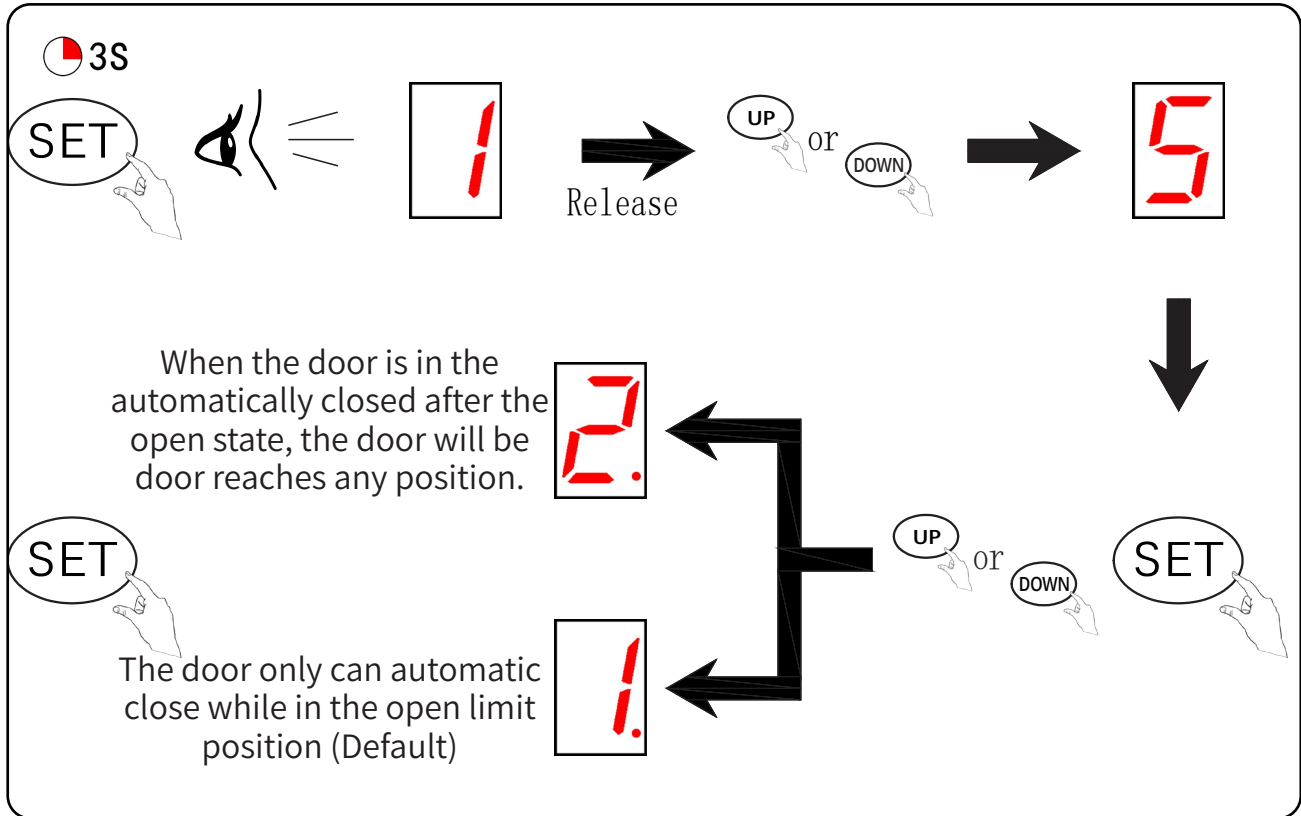

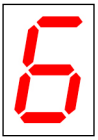

: LED off delay time setting

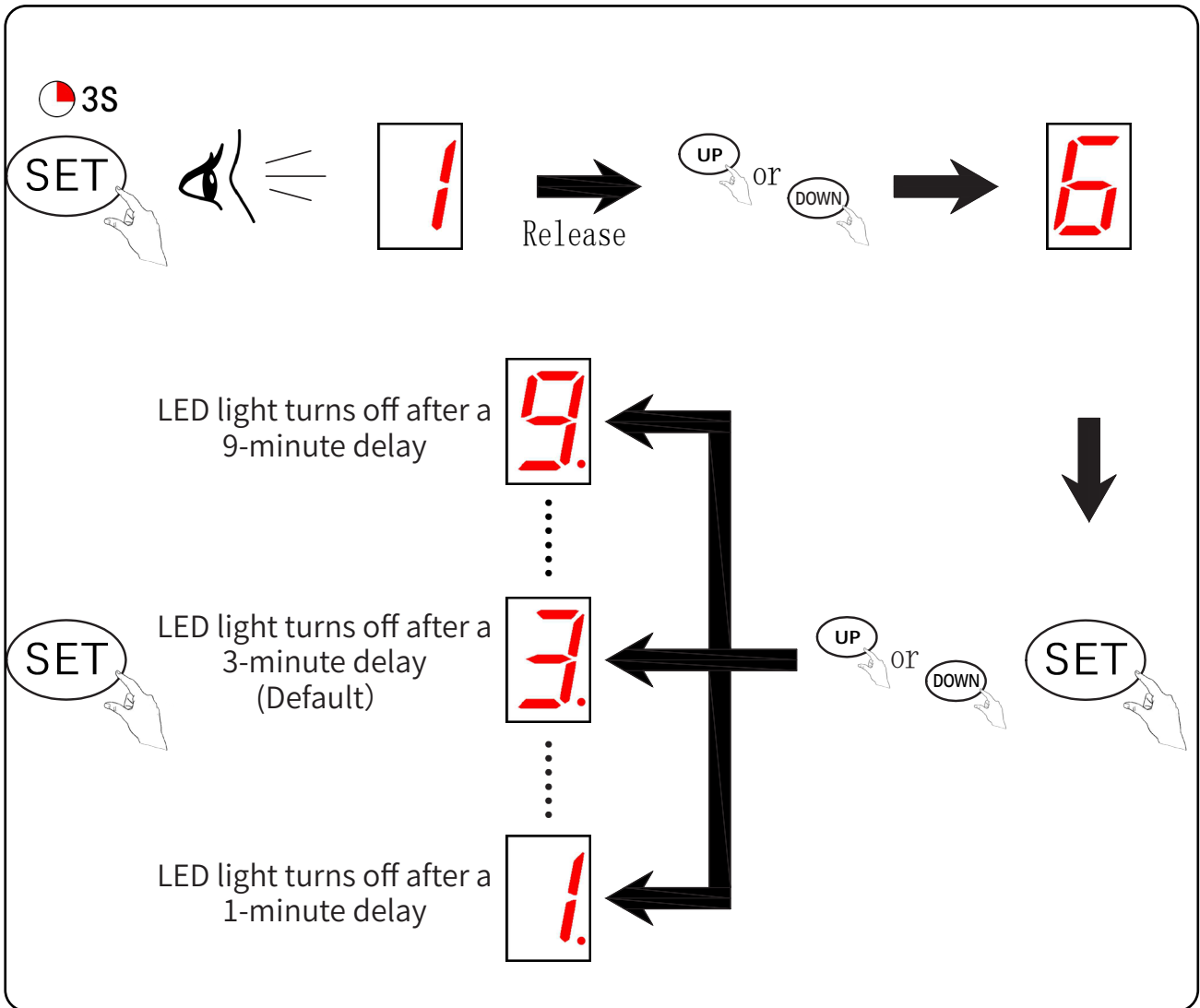



: Reversal running time setting (After the resistance rebound)

- ① Option 0: Door stops at open limit upon reversal (default).
- ① Options 1–9: Door reverses for 1–9 seconds

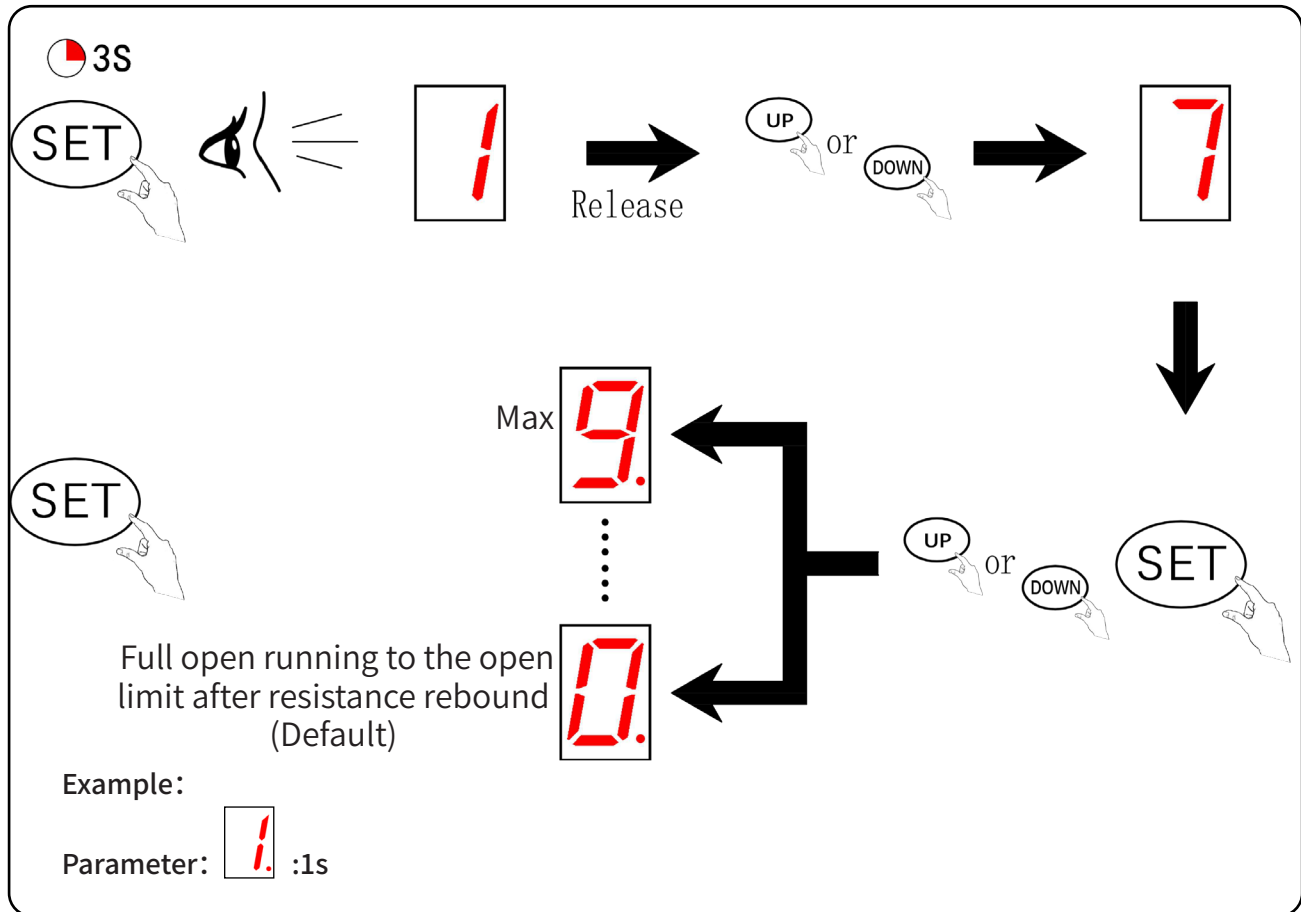



: Partial Open ON/OFF Setting/Height Setting

- ① When the partial open/height function is activated, the button's recognition function will be deactivated.
- ① When the partial open function was initially enabled and subsequently disabled, that only the initially programmed button can now control the opener.

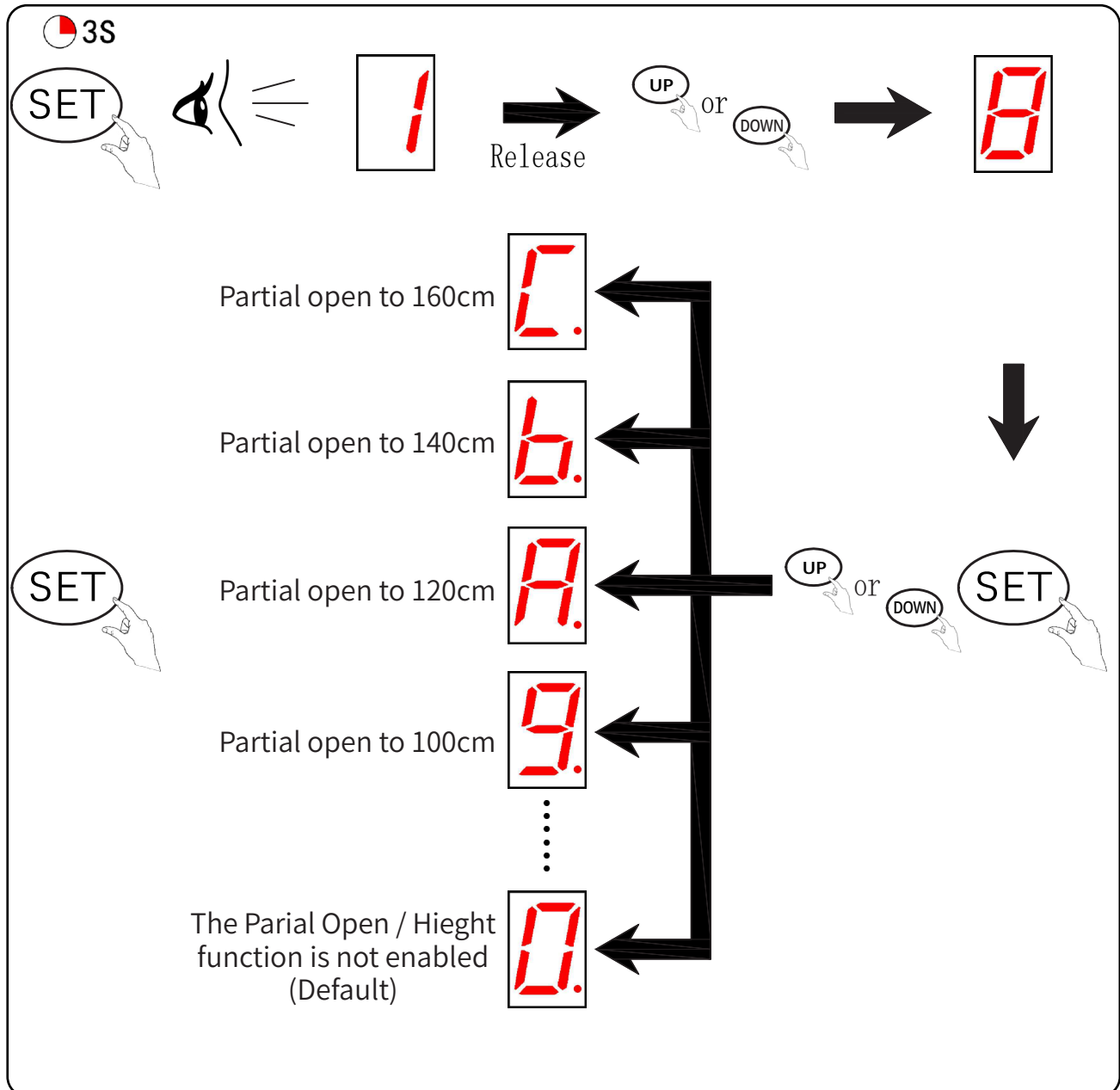

	The Partial Open / Hieght function is not enabled (Default)
	Partial open to 2cm.
	Partial open to 4cm.
	Partial open to 8cm.
	Partial open to 12cm.
	Partial open to 20cm.
	Partial open to 40cm.
	Partial open to 60cm.
	Partial open to 80cm.
	Partial open to 100cm.
	Partial open to 120cm.
	Partial open to 140cm.
	Partial open to 160cm.



: Transmitter Button Recognition Setting

- ⓘ Note: The "8" function (Partial Open/Height Setting) must be turned off before using the transmitter recognition function
- ⓘ Parameter "0" disables button recognition. If you have only one automatic door, all four buttons on the remote can control it.
- ⓘ Parameter "1" enables button recognition. Only the first button will control the opener if it is coded to the first opener. This is suitable for users with multiple automatic doors or gates.

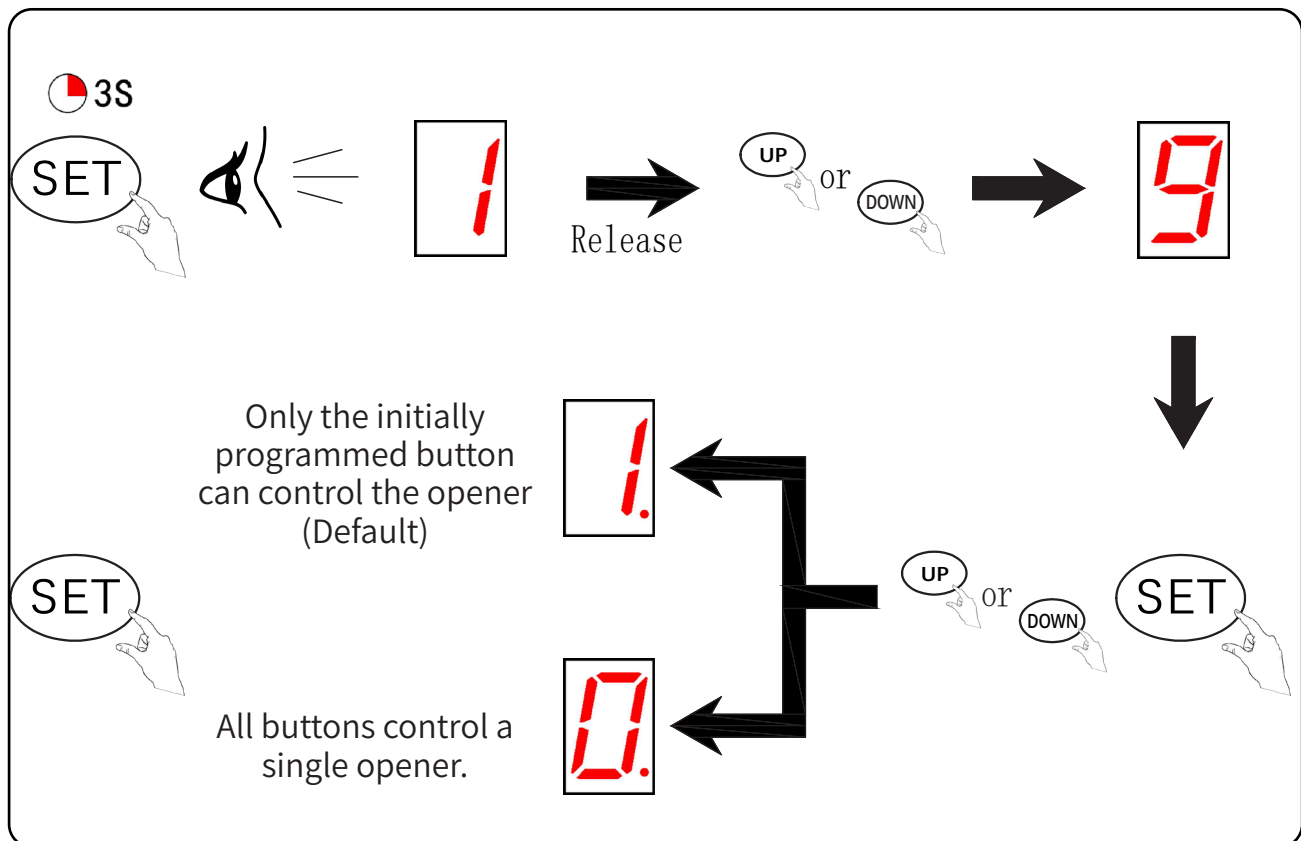

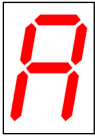

: Soft stop distance adjustment

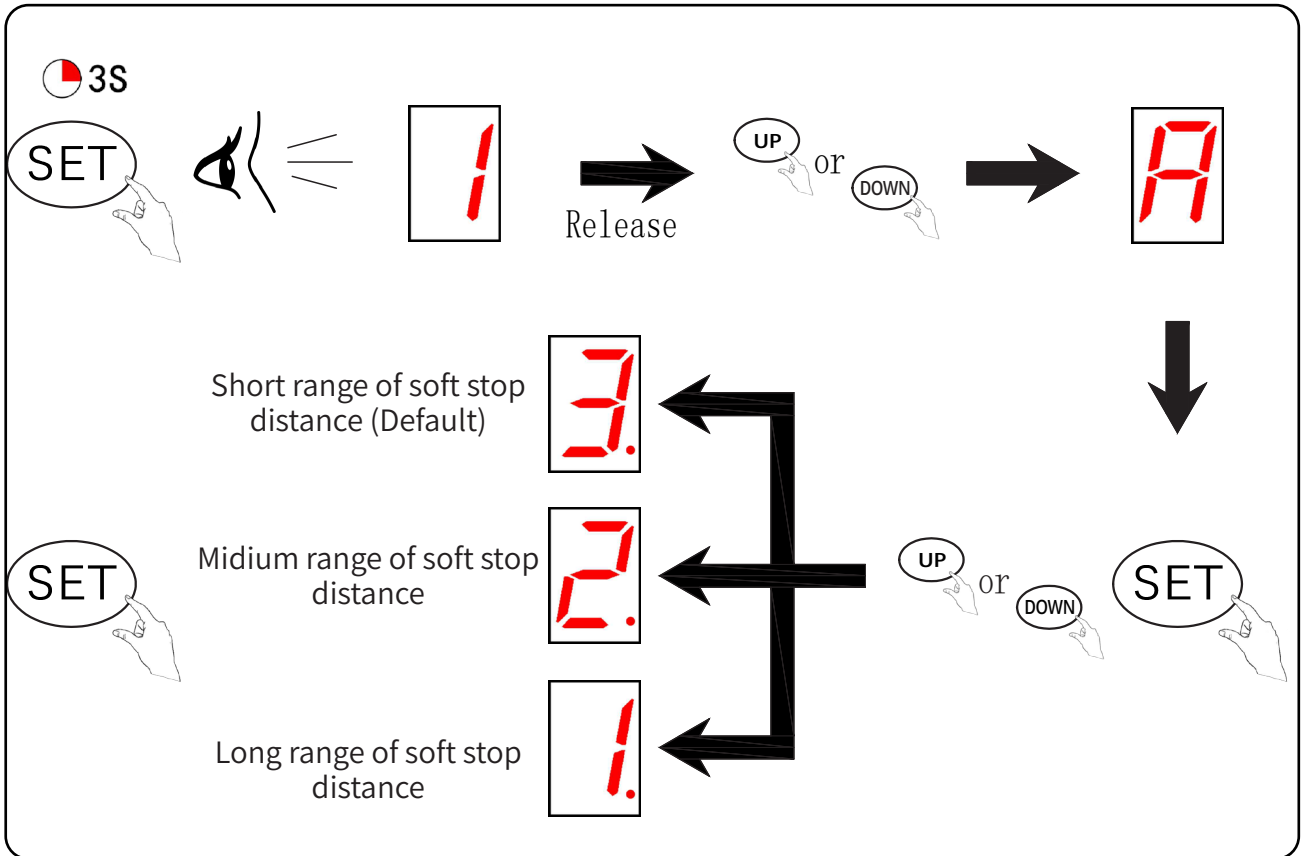

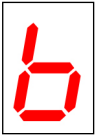

: Reversal Position Ignorance While obstruction

- ① Range: 1–9 cm (door ignores obstructions near the closed position).
- ① Use Case: Ideal for snowy environments.

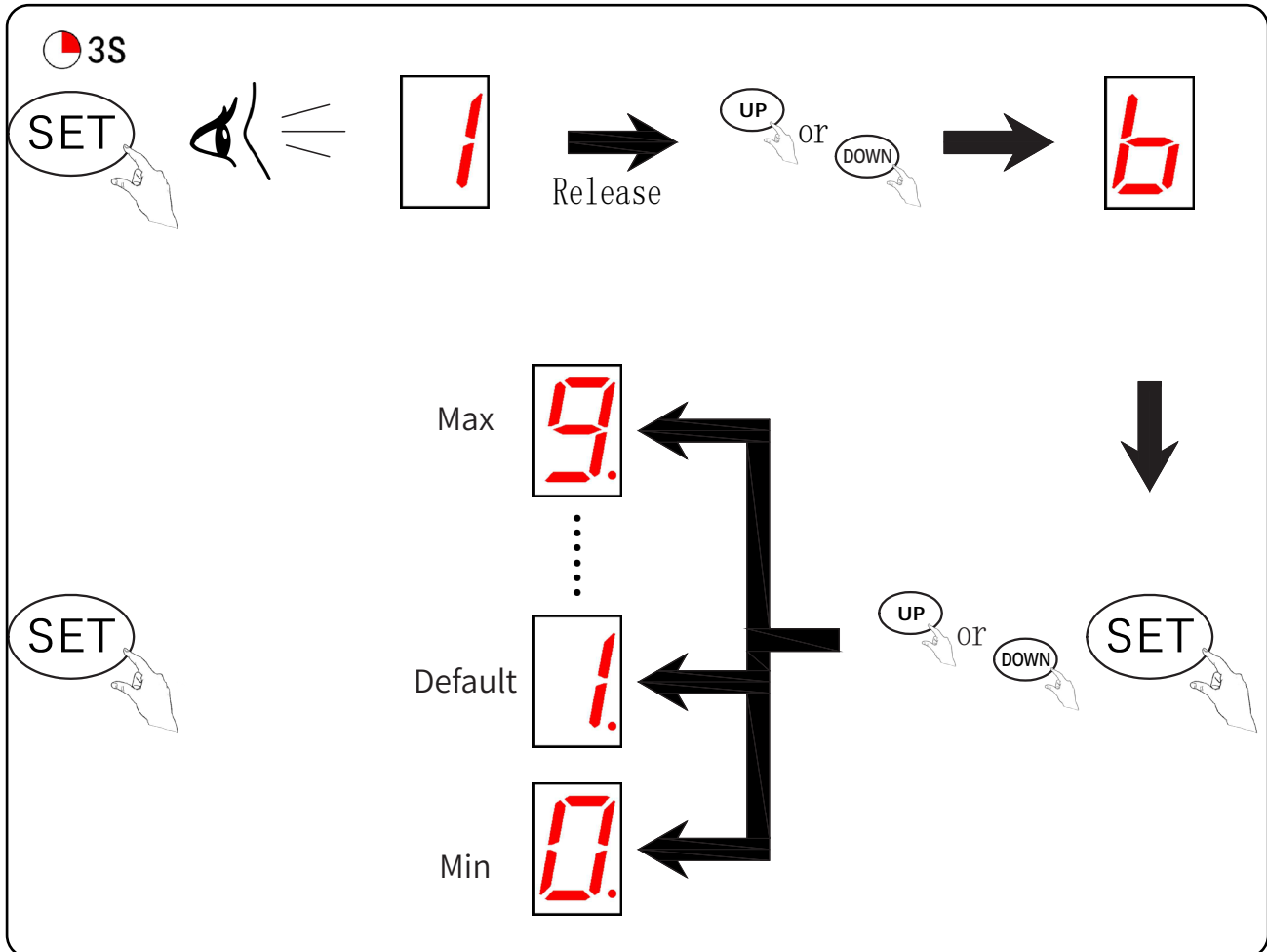

The motor stops immediately without reversing if an obstacle is detected while closing the door in the designated area.

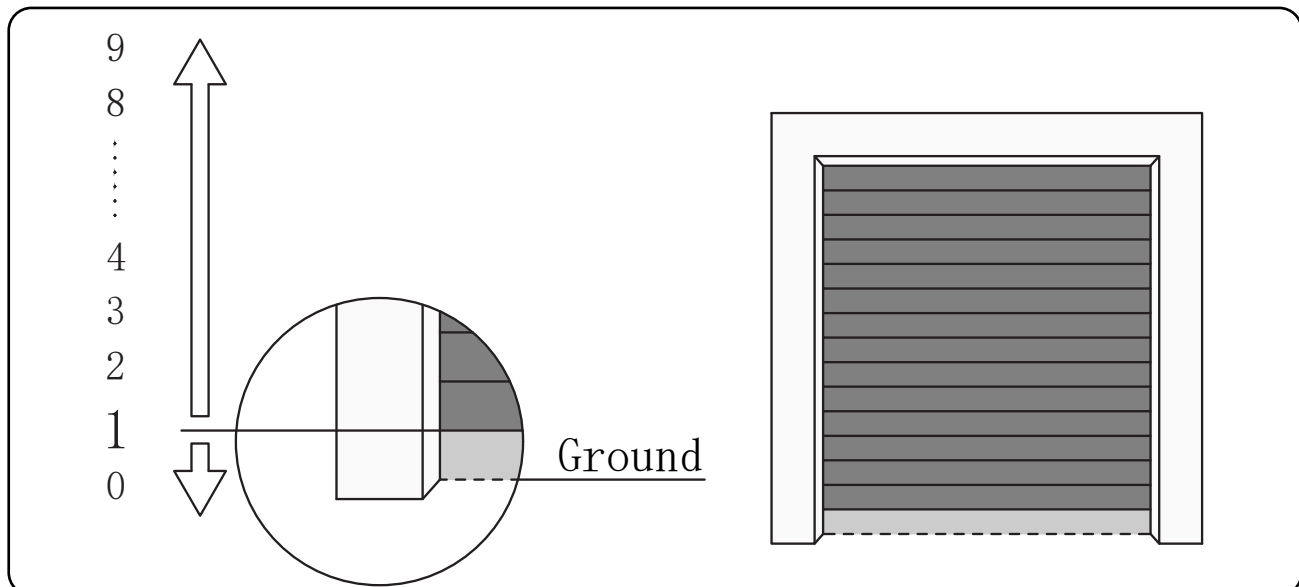

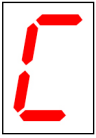

: Wired pass door sensor port setting (NO/NC)

i Connection Description: SD-GND port

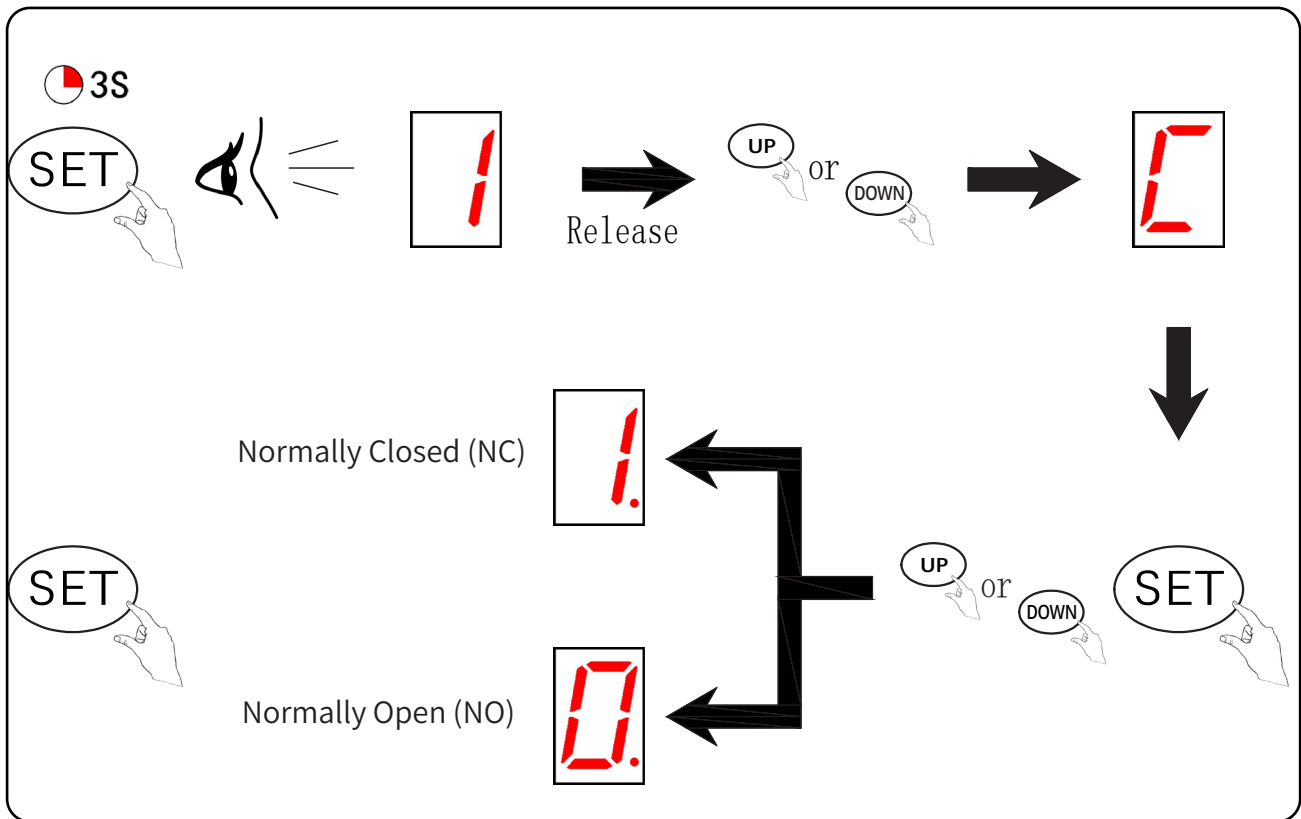

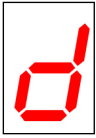

: Wired photo beam function ON/OFF Setting

① Connection Description: PE-GND port

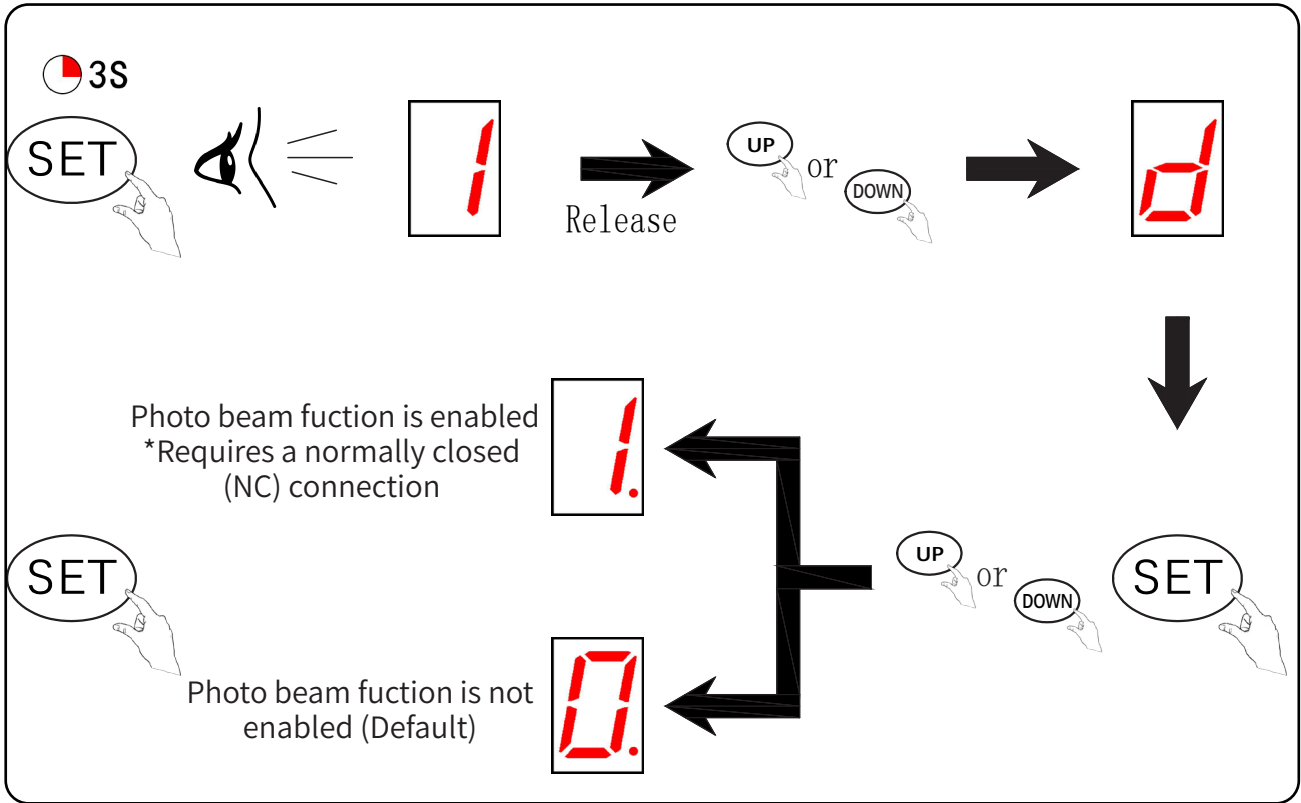

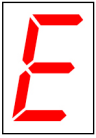





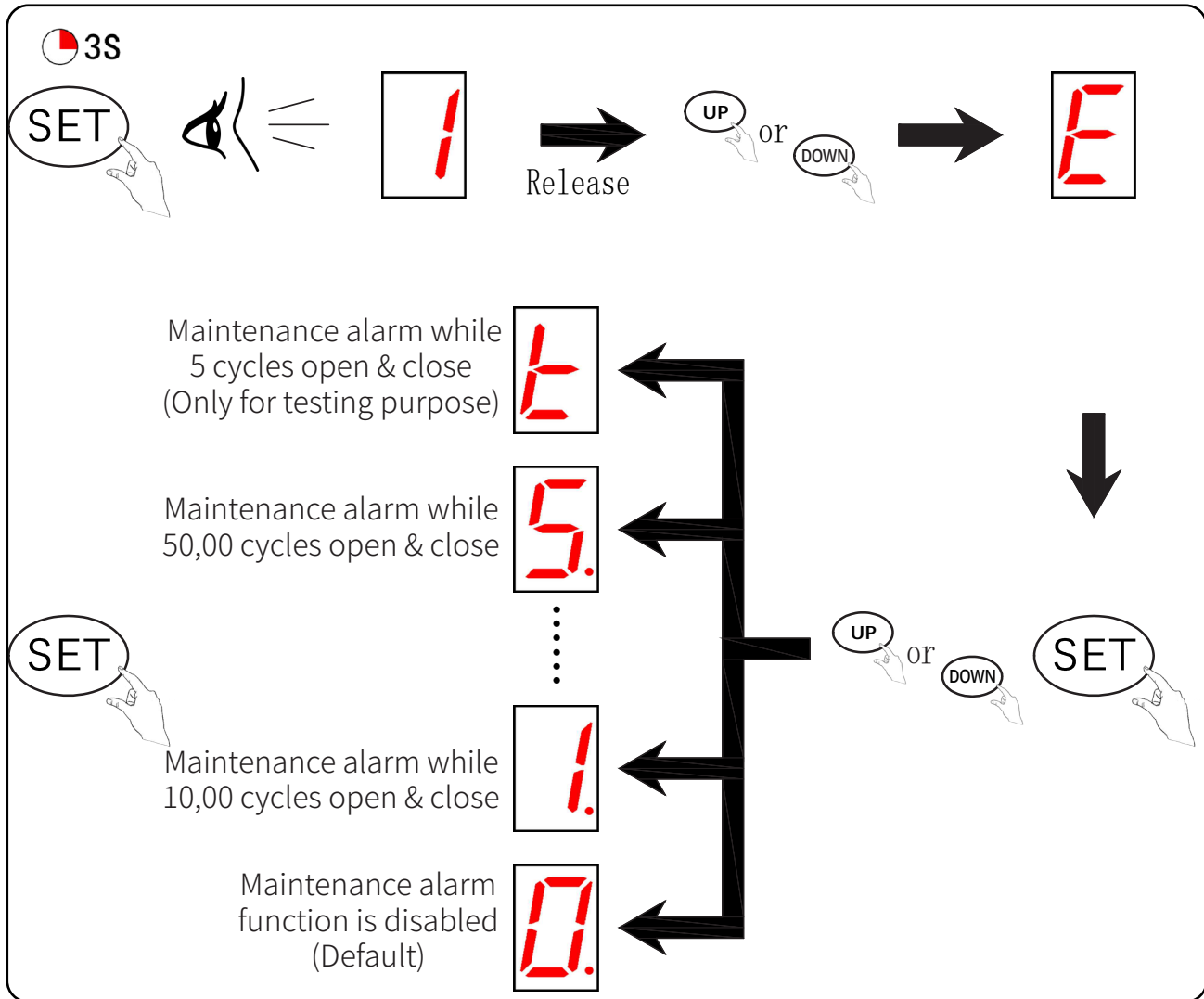

: Maintenance alarm-operation cycles count setting

ⓘ Note:

LED flashes 10 times upon imbalance or maintenance requirement. Check the door balance or re-learn the travel limit of the garage door.

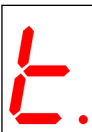

	<p>Maintenance alarm function is disabled (Default)</p>
	<p>Maintenance alarm while 10,00 cycles open & close</p>
	<p>Maintenance alarm while 2,000 cycles open & close</p>
	<p>Maintenance alarm while 3,000 cycles open & close</p>
	<p>Maintenance alarm while 4,000 cycles open & close</p>
	<p>Maintenance alarm while 5,000 cycles open & close</p>
	<p>Maintenance alarm while 5 cycles open & close (Only for testing purpose)</p>

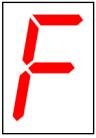

: Community function (Parking lot function) ON/OFF

i Function Activation Instructions:

- If the remote is triggered while the door is closing, the door will open immediately.
- If the remote triggered is while the door is opening, there will be no response.

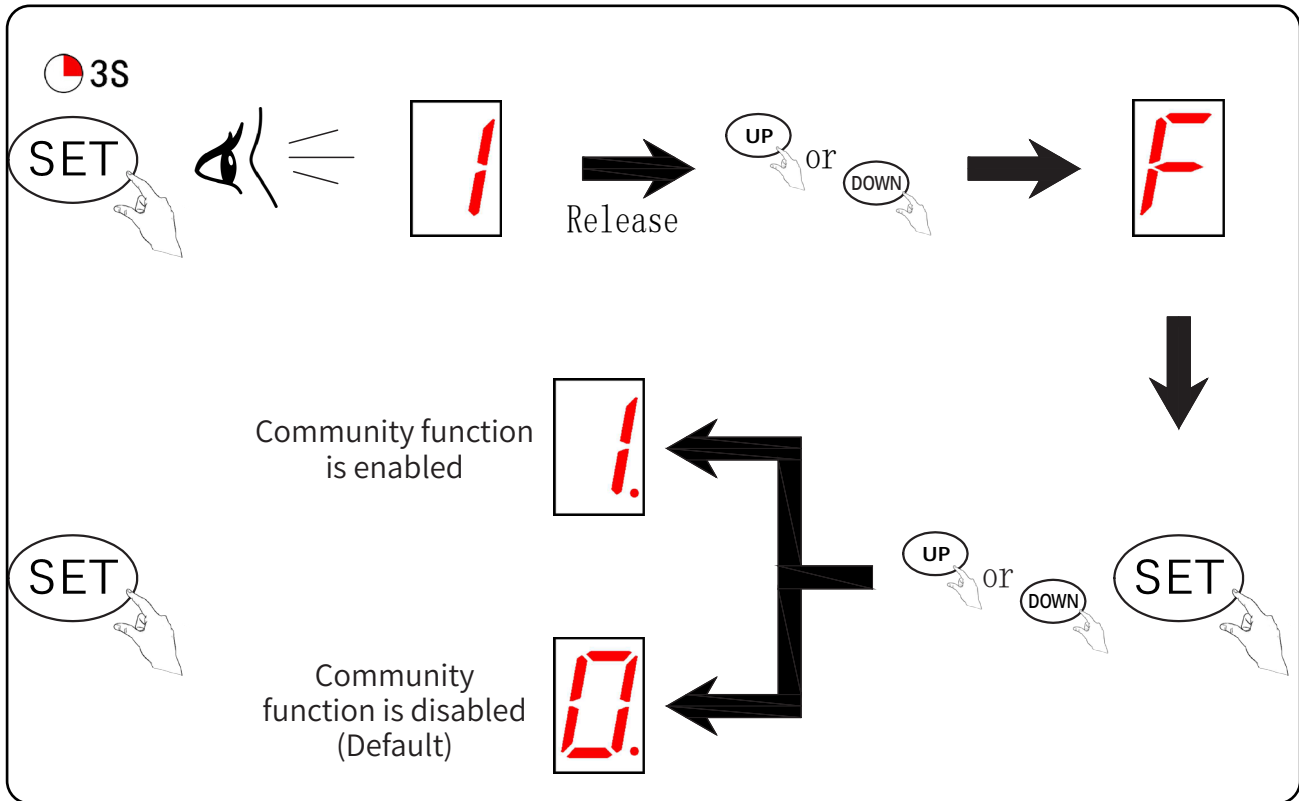

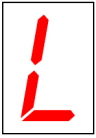

: Opening lifting force adjustment

Caution:

The opening lifting force has been set automatically after travel limit programmed, manual adjustment is unnecessary normally.

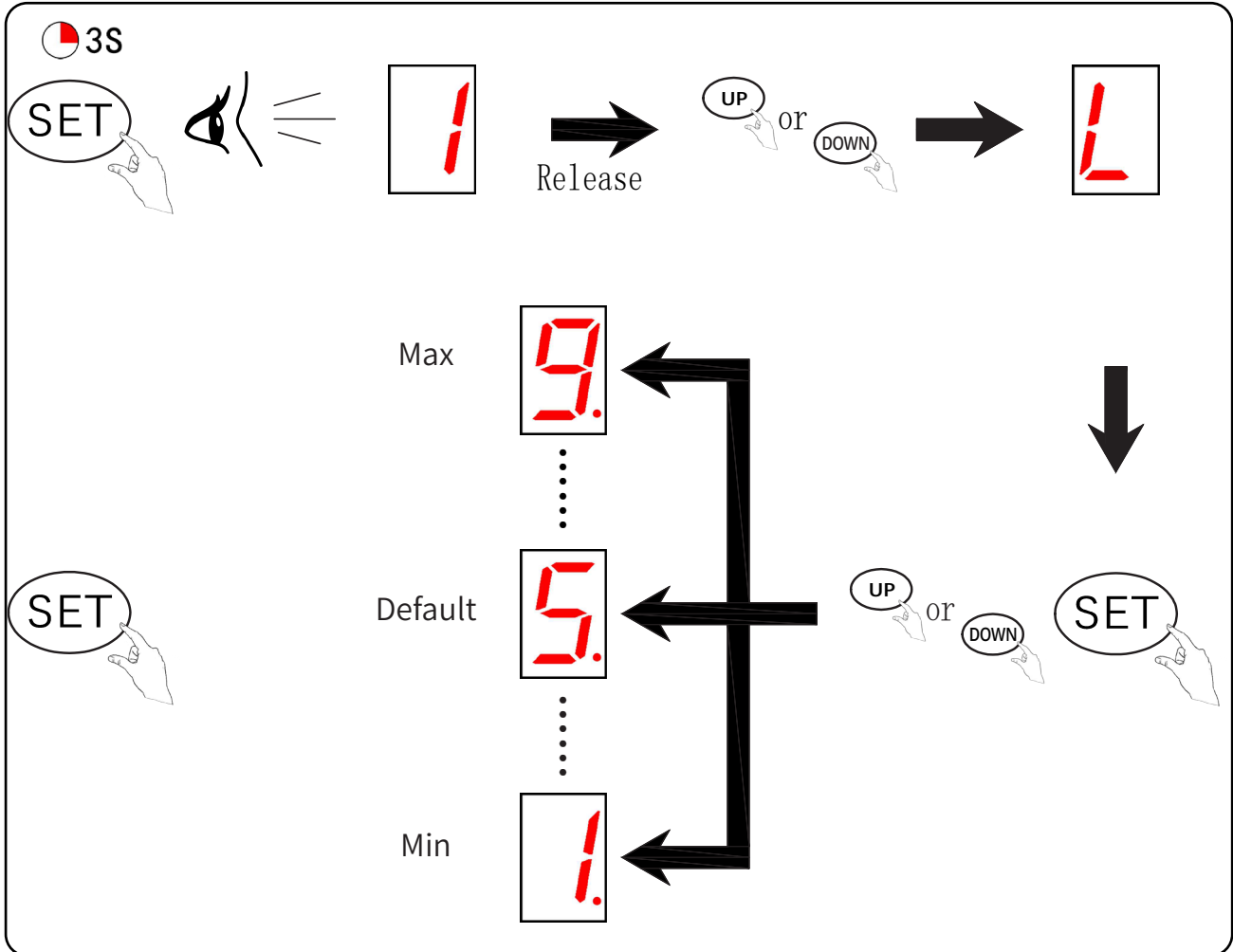

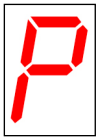

: Wired E-Lock Function ON/OFF



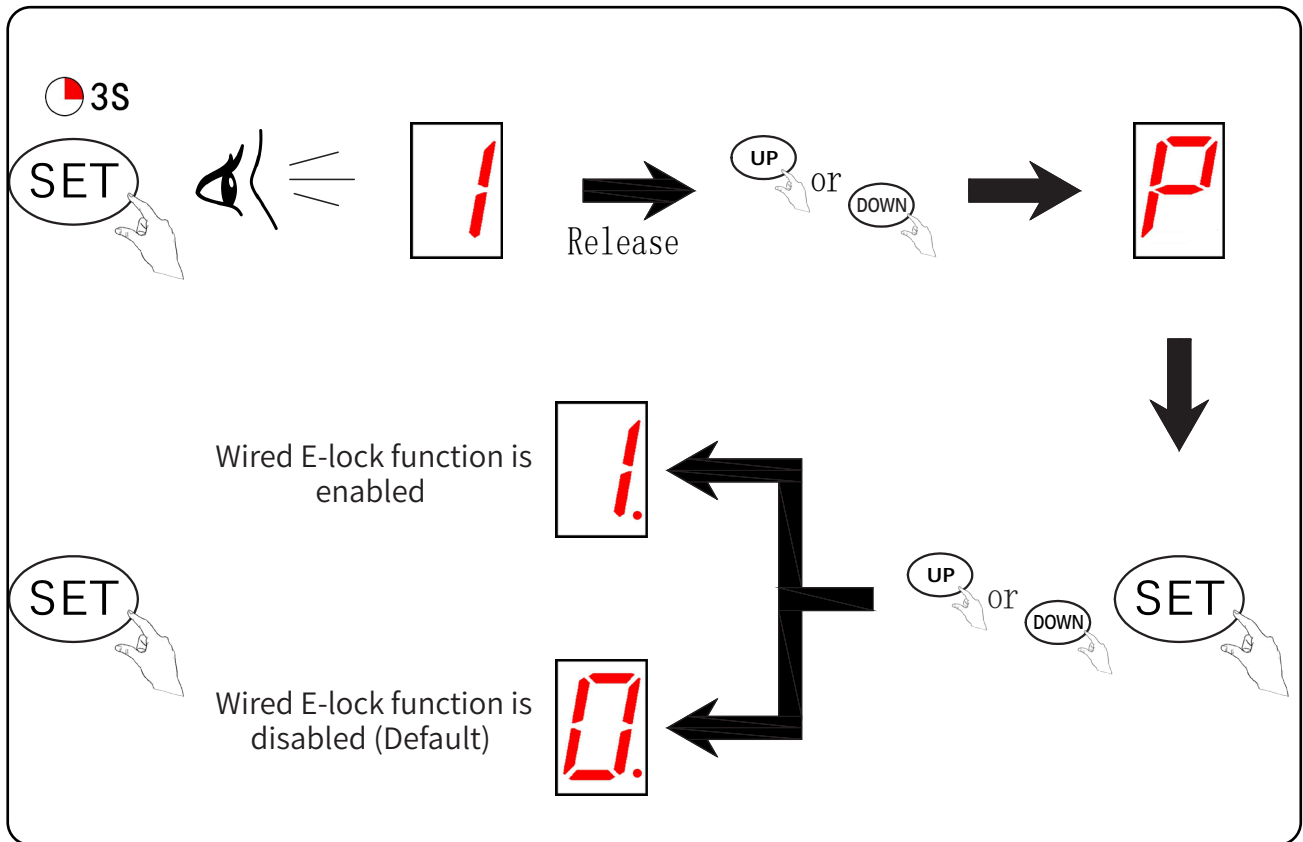

① Connect the wired E-lock to the E-lock port of the motor.

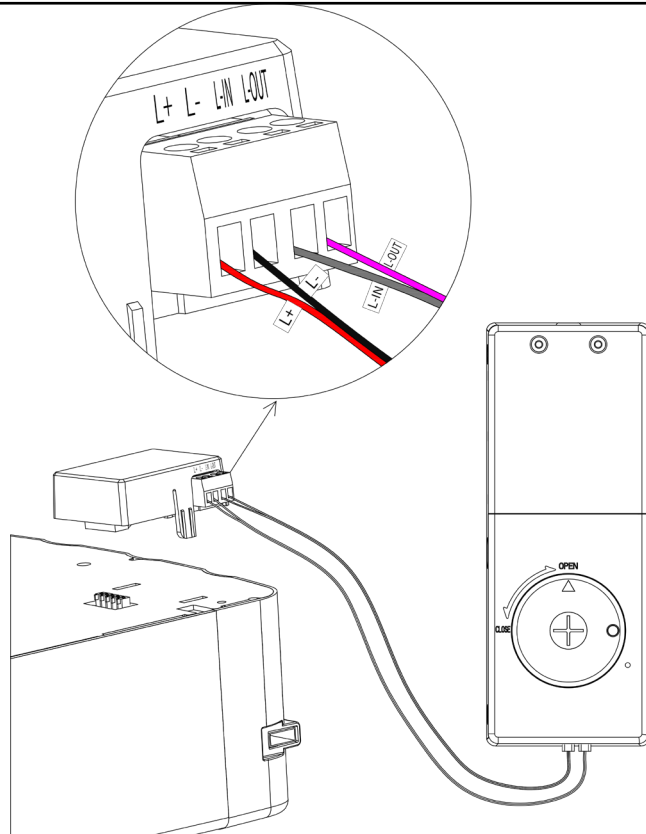



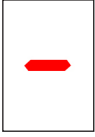
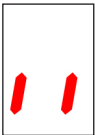
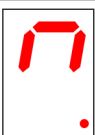
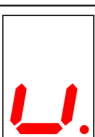

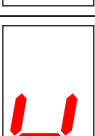
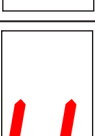
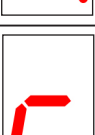

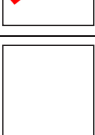
Wired E-lock wiring diagram:



13.RUNNING DISPLAY CODES

Display information	
	No travel limit set
	Standby status display
	Open limit learning status display
	Close limit learning status display
	Door is opening
	Door is closing
	Pass door triggered
	Wired photo beam triggered
	Wired E-lock triggered
	Transmitter learning

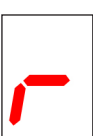
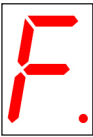
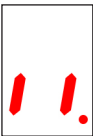
14.COMMON FAULT & SOLUTIONS

Fault display code	Problem Description	Solution
	1. Door travel range exceeds maximum threshold (9m) or falls below minimum requirement (30cm). 2. The door loses balance and affects the proper operation of the motor.	1. Learn the proper travel limit range. 2. Check the door balance (Mechanical parts and springs) or replace a stronger power motor.
	Abnormal voltage input (A low input voltage), or unbalanced door weights.	1. Check the power supply for a right input voltage. 2. Check the door balance (Mechanical parts and springs) or replace a stronger power motor.
	Fail to learn the up and down limit setting Improperly learn the up and down limit setting	Learn "UP" and "DOWN" limit setting again follow the manual
	Hall sensor/wiring fault/ Component fault on PC board.	1. Inspect connections. 2. Replace the PC board.
	Reversed Motor Wiring to PC board.	1. Disconnect from main power supply. 2. Reverse the polarity of gear motor wiring connections at the terminal block. 3. Programme the travel limit.
	The wired photo beam function remains active despite no photo beam being installed.	1. Deactivate the wired photo beam function refer to the manual. 2. Verify proper wiring termination and ensure no physical obstructions are interfering with photoelectric detection.
	Exceeds limit of paired remote controls.	Delete all stored codes on the Opener (Refer the instruction manual).
	Pass door safety protection function is triggered	1. Check the pass door and ensure it has been closed completely. 2. Check the pass door sensor performance.
	1. Wired E-Lock is triggered or faults. 2. The wired E -Lock function (Parameter "P") has been enabled but no wired E-lock is installed.	1. Inspect the electrical connections of the wired E-lock for proper termination and continuity. 2. Verify the operational integrity of the wired E-lock, checking for Physical damage or component malfunction. Improper retraction of the locking bolt mechanism.

Fault Symptom	Potential Causes	Recommended Solutions
No Response from Openers	1. Power supply interruption	1. Inspect E-Lock wiring integrity
	2. Loose wiring connections	2. Verify E-Lock functionality (ensure bolt retracts properly)
LCD Screen Inoperative	1. Power supply failure	1. Check main power input
	2. Faulty E-Lock mechanism	2. Replace damaged E-Lock components
Position Calibration Error	System limit setting misalignment	Reset travel limits via control panel
LED Indicator Continuously On	1. Control panel malfunction	Replace control board or power supply board
	2. Power board failure	
Caution Light Persists	Circuit board damage	Replace main circuit board
LED Failure	1. Disconnected LED wiring	1. Reconnect LED cables
	2. LED unit defect	2. Install new LED module
	3. Circuit board fault	3. Replace circuit board
Premature Door Reversal	1. Obstruction detected	1. Clear obstruction path
	2. Incorrect door installation	2. Reinstall door track
	3. Travel limit misaligned	3. Adjust force sensitivity and reset travel limits

Fault Symptom	Potential Causes	Recommended Solutions
Door Halts During Opening	1. Safety sensor activation	1. Clean sensor lenses
	2. Track misalignment	2. Realign door track
	3. Foreign object blockage	3. Remove obstructions
Remote Control Malfunction	1. Depleted battery	1. Replace battery
	2. Antenna disconnection	2. Secure/extend antenna
	3. Signal interference	3. Eliminate nearby RF sources
Remote Pairing Failure	Incompatible remote model	Use manufacturer-approved remote control
Motor Runs, Door Static	Motor-rail coupling failure	Inspect and reattach motor-drive rail linkage
Battery Failure	1. Discharged battery	1. Recharge battery
	2. Reverse polarity connection	2. Verify terminal orientation (+/-)
	3. Damaged wiring	3. Replace defective cables
Other Anomalies	External device incompatibility	1. Disconnect non-certified devices
		2. If unresolved, replace circuit board