

# Installation Instruction User Guides



**FRV**

Receiver for wireless safety system

Version 2.0



# I. Description

## 1.1 Overview

FRV is a simplified smart door control with core wireless sensor communication functions. With a more compact design, FRV is designed to provide reliable wireless security solutions for garage/industrial doors and other occasions, especially suitable for application scenarios with limited space or no remote control required.

## 1.2 Features and Advantages

**Compact design:** FRV's smaller size makes it easier to install in space-constrained environments.

**Wireless security communication:** It supports communication with wireless safety edge, wireless wicket door switch, wireless slack rope switch and wireless photo beam to ensure the safety of the door control system. From potential security risks are provided and guaranteed.

**Easy operation:** Without the need for an APP, FRV can directly perform security monitoring and control through built-in wireless sensors, which is suitable for simplified application scenarios.

## 1.3 Use scenarios and functions

FRV is suitable for garage door openers, industrial door drives and other occasions that require wireless security monitoring. Although the IoT (Internet of Things) connection is removed, FRV can still manage wireless photo beam, wireless safety edge, slack rope switch, etc., providing a stable intelligent door control upgrade solution.

# II. Features and Technical Data

## 2.1 Features

- 3 relay outlets with selectable operating mode. Can behave like a safety contact for reversal function or stop function
- Low voltage port for flash light contact with 12-24V, high voltage port for flash light contact with 120- 230V
- Indicator LED lights for the safety sensors
- Built-in trio frequency module for anti-interference
- Fast code buttons for wireless safety sensors and position sensor

## 2.2 Technical Data

Model	FRV
Radio technology	Trio-Frequency technology
Frequency	Multi from 409.025 MHz – 458.4 MHz
Signal modulation	FSK
Signal range	20 meters
Power supply	12-24 V AC/DC
Number of relays	3 relays
NC/NO	Adjustable
Operating temperature	-20°C - + 60°C

## III. Product Composition Display

### 3.1 FRV Product Composition Display

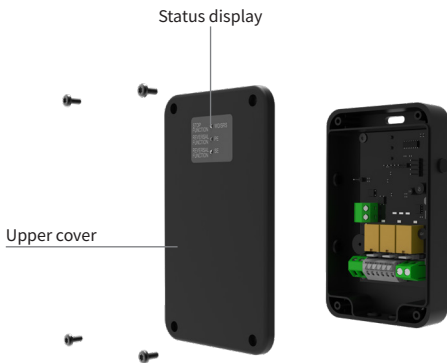

## 3.2 Compatible safety accessories

3.2.1 As a safety receiver, FRV is capable of pairing with the following devices:

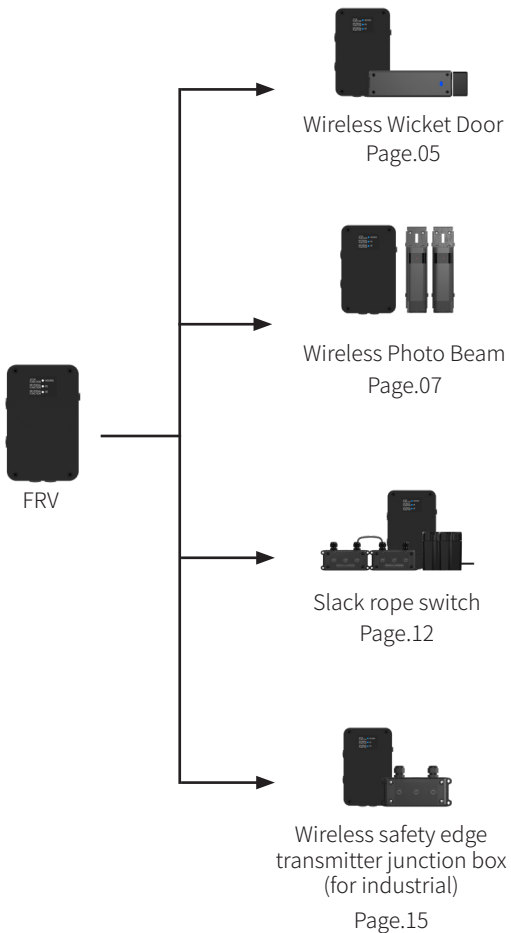



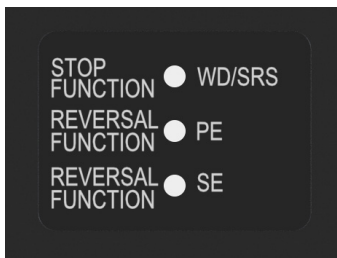

### 3.3 Status display LED description

By figure bellow for example of LED color to show working status wireless safety devices.



Different LED colors correspond to wireless safety device status:

LED Color \ Device Name	Green 	Red 	Cyan 	Purple 	White 
WD/SRS	Working fine	Function triggered	Low battery	Low battery and is triggered	Lost connection
PE	Working fine	Function triggered	Low battery	Low battery and is triggered	Lost connection
SE	Working fine	Function triggered	Low battery	Low battery and is triggered	Lost connection

STOP FUNCTION: The motor stops running

REVERSAL FUNCTION: The motor reverses to open the door during the closing process

### 3.4 Configuration/pairing of FRV and wireless security accessories

#### A. FRV + transmitter for wicket door (F-WICKET-1)

Once the FRV has successfully paired with transmitter for wicket door (the indicator light solid on), wire FRV SD port to motor's pedestrian door port.



##### A.1. Wiring diagram

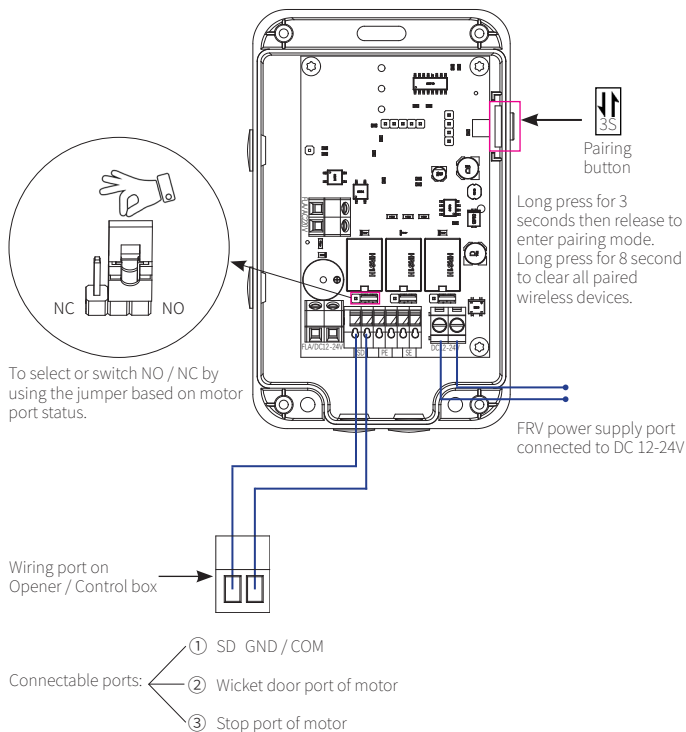

NC NO



Pairing button

Long press for 3 seconds then release to enter pairing mode. Long press for 8 second to clear all paired wireless devices.





FRV power supply port connected to DC 12-24V

Wiring port on Opener / Control box

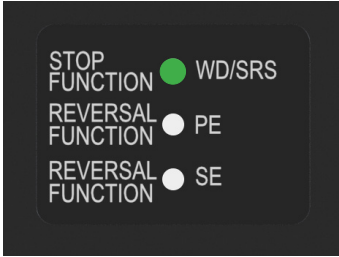
- Connectable ports:
- ① SD GND / COM
  - ② Wicket door port of motor
  - ③ Stop port of motor

A.2. Corresponding indicator light status description



LED Color \ Device Name	Green 	Red 	Cyan 	Purple 	White 
WD/SRS	Working fine	Function triggered	Low battery	Low battery and is triggered	Lost connection

A.3. Installation location and operating principle

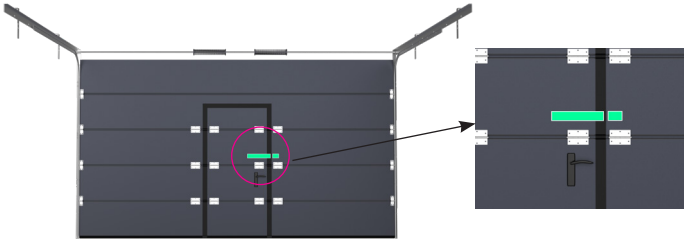

In order to ensure that the door will not be damaged when the door/gate is running, it is necessary to detect the status of the door (open or closed):  
 When the wicket door is closed, the wireless wicket door device is not triggered and the full door can operate.  
 When the wicket door is opened, the wireless wicket door device is triggered and the full door can not be operated to avoid any damage to the full door.



## B. FRV + wireless photo beam (F-BEAM-1)

Once the FRV has successfully paired with wireless photo beam (the indicator light solid on), wire FRV PE port to motor's PE port.



### B.1 Wiring diagram

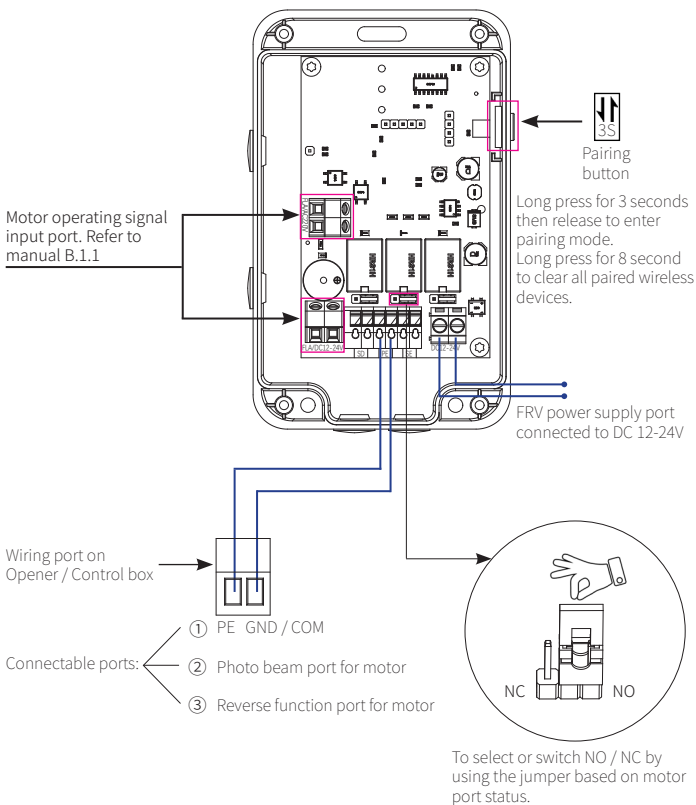

## B.1.1 Operating signal input wiring

### Note:

Be sure to connect the operating signal port of FRV to the relative port of motor before you pair FRV with a wireless photo beam or a wireless safety edge. Otherwise, could cause functional failure.

### 1. Motor operating signal: flash light / warning light

Motor AC 110~220V flash light or warning light port



Motor DC 12~24V flash light or warning light port



Note: Ensure that the indicator light is flashing during motor operating

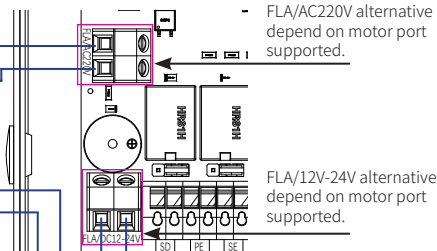

### 2. Motor operating signal: relay output port or AUTO TEST port

Relay output port wiring diagram 1:

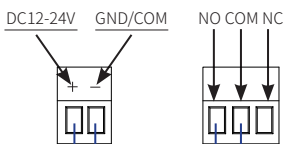

Note: The relay output wiring requires to enable the warning light function. (simulating the working state of warning light.).

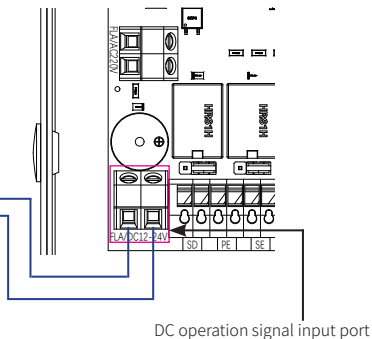

## Relay output port wiring diagram 2:

(AC110-220V)

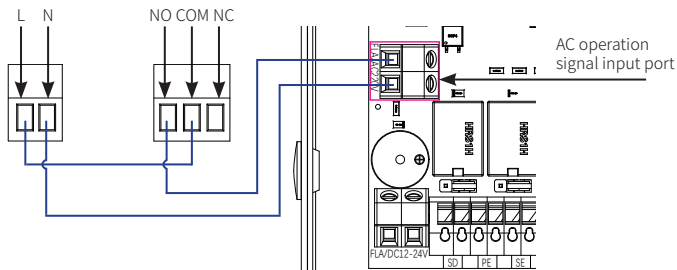

Note: The relay output wiring requires to enable the warning light function. (simulating the working status of warning light.).

## AUTO TEST port

AUTO TEST COM

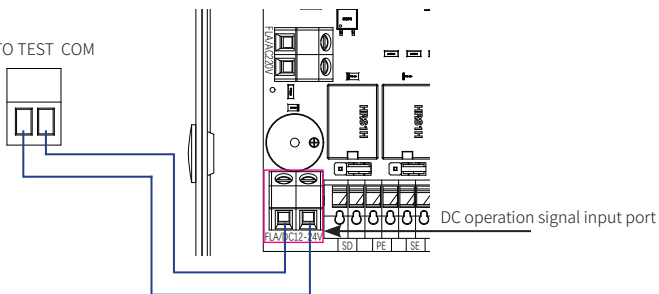

Note: Please confirm whether the auto test port is DC or AC, and then connect it to the corresponding port of FRV.

### 3. Motor operating signal: motor power supply signal

Note: Please perform wiring under the guidance of a qualified professional.

DC motor wiring diagram:

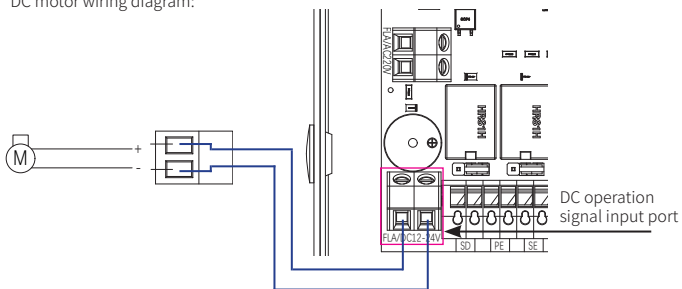

AC 220V motor wiring diagram  
(Not compatible with AC 380V motors)

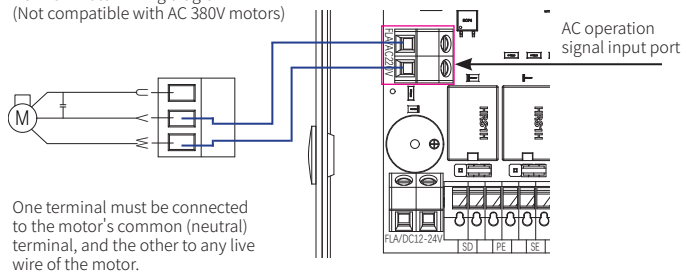

One terminal must be connected to the motor's common (neutral) terminal, and the other to any live wire of the motor.

Note: Do not connect the two live wires of the motor.  
Excessive voltage may cause the circuit board to overheat and be damaged.

## B.2. Corresponding indicator light status description

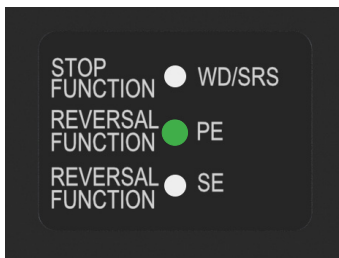

LED Color \ Device Name	Green	Red	Cyan	Purple	White
PE	Working fine	Function triggered	Low battery	Low battery and is triggered	Lost connection

## B.3. Installation location and operating principle

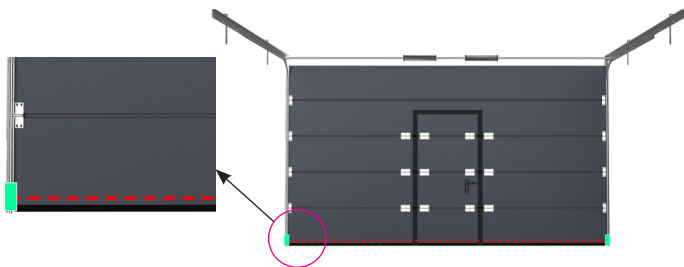

During the door closing process, the device can monitor in real time whether someone passes through the door to ensure safety during door operation. When it detect the obstacle pass through, the door will automatically stop and reverse to the open limit position.

## C. FRV + slack rope switch (F-CORD-2-1)

Once the FRV has successfully paired with slack rope switch (the indicator light solid on), wire FRV SL port to motor's SL port. (Wireless door-in-door port and slack rope switch port share one port)



### C.1. Wiring diagram

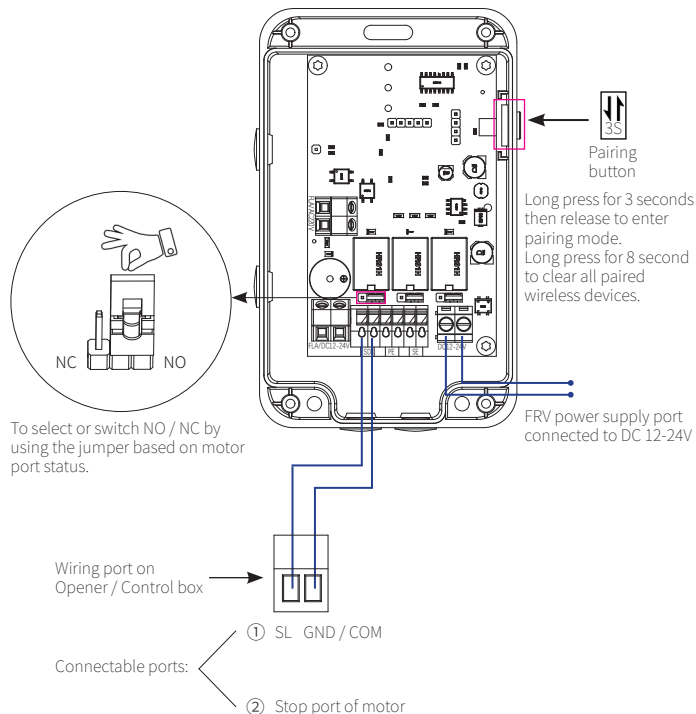

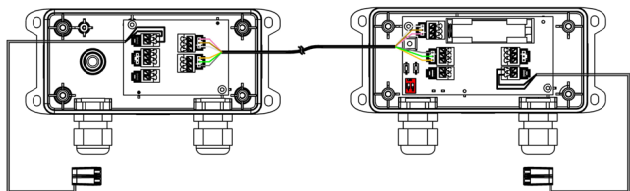

For detailed information on wiring the Slack Rope Switch, please refer to the SE-TX 03 Safety Edge Transmitter Junction Box Kit Instruction Manual.

## C.2. Corresponding indicator light status description

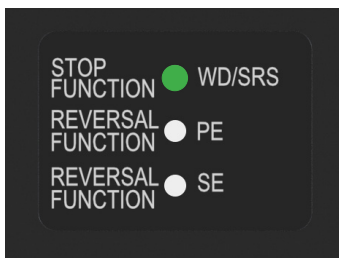

LED Color	Green	Red	Cyan	Purple	White
Device Name	WD/SRS	PE	SE	WD/SRS	SE
WD/SRS	Working fine	Function triggered	Low battery	Low battery and is triggered	Lost connection

### C.3. Installation location and operating principle

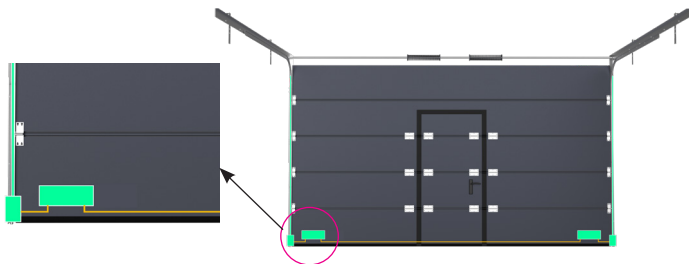

In order to ensure the safe operation of the door, it is necessary to detect whether the rope/cable of the door is loose:

If the wire rope/cable becomes loose, the safety system will give an alarm to take corresponding measures for safety.



## D. FRV + industrial safety edge transmitter (F-EDGE 02-1)

Once the FRV has successfully paired with safety edge transmitter (the indicator light solid on), wire FRV SF port to motor's SF port.



### D.1. Wiring diagram

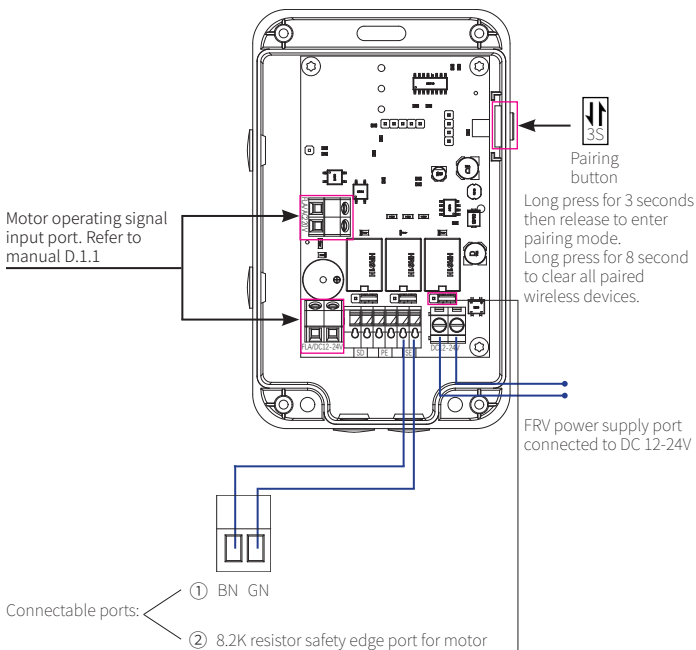

#### Functional logic diagram

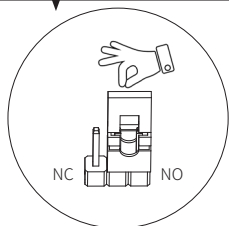
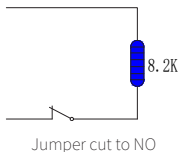
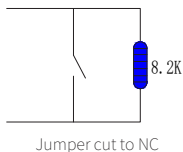

To select or switch NO / NC by using the jumper based on motor port status.

## D.1.1 Operating signal input wiring

### Note:

Be sure to connect the operating signal port of FRV to the relative port of motor before you pair FRV with a wireless photo beam or a wireless safety edge. Otherwise, could cause functional failure.

### 1. Motor operating signal: flash light / warning light

Motor AC 110~220V flash light or warning light port



Motor DC 12~24V flash light or warning light port



Note: Ensure that the indicator light is flashing during motor operating

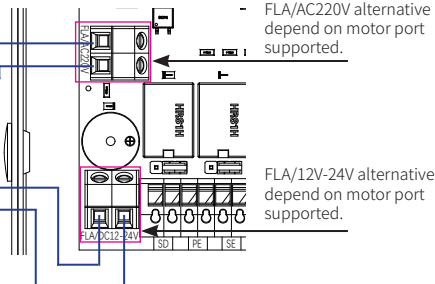

### 2. Motor operating signal: relay output port or AUTO TEST port

Relay output port wiring diagram 1:

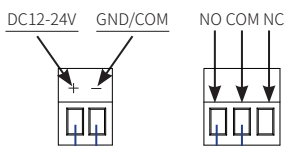

Note: The relay output wiring requires to enable the warning light function. (simulating the working state of warning light.).

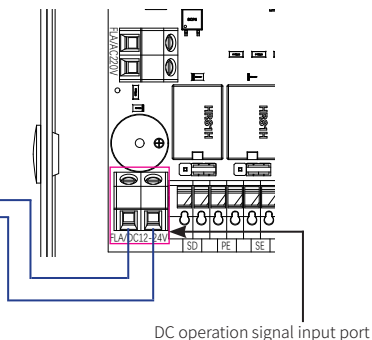

Relay output port wiring diagram 2:

(AC110-220V)

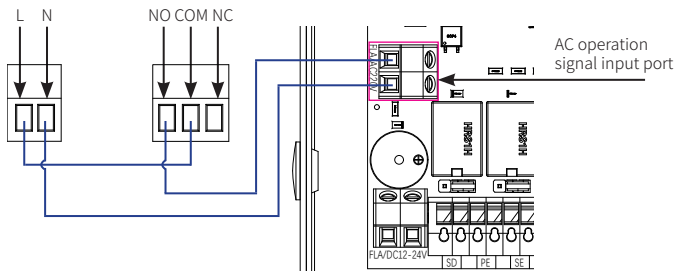

Note: The relay output wiring requires to enable the warning light function. (simulating the working status of warning light.).

AUTO TEST port

AUTO TEST COM

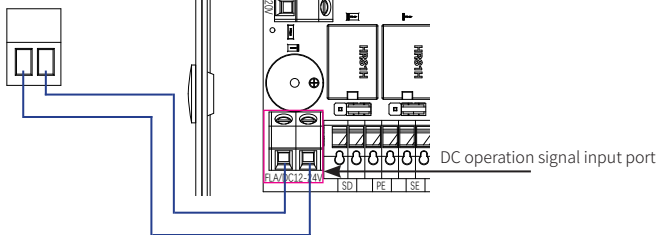

Note: Please confirm whether the auto test port is DC or AC, and then connect it to the corresponding port of FRV.

### 3. Motor operating signal: motor power supply signal

Note: Please perform wiring under the guidance of a qualified professional.

DC motor wiring diagram:

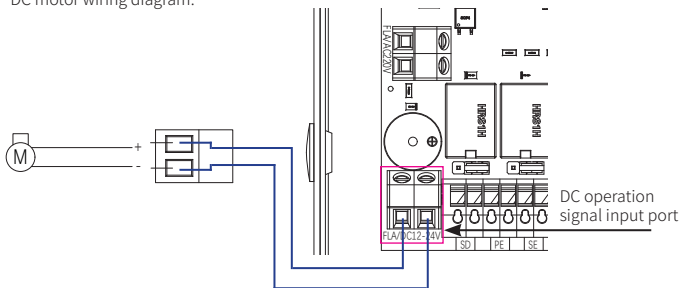

AC 220V motor wiring diagram  
(Not compatible with AC 380V motors)

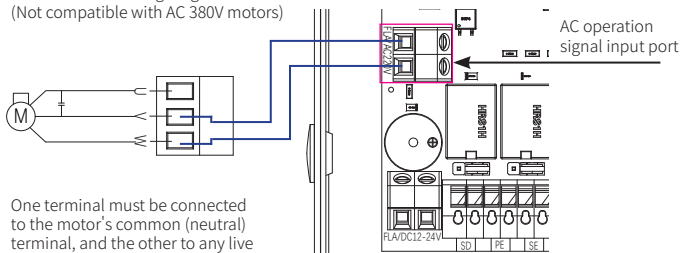



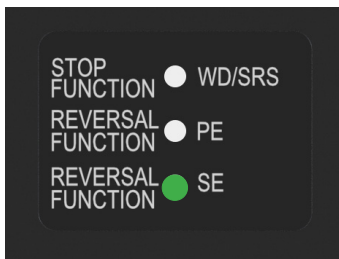

One terminal must be connected to the motor's common (neutral) terminal, and the other to any live wire of the motor.

Note: Do not connect the two live wires of the motor.  
Excessive voltage may cause the circuit board to overheat and be damaged.

## D.2. Corresponding indicator light status description



LED Color	Green	Red	Cyan	Purple	White
Device Name					
SE	Working fine	Function triggered	Low battery	Low battery and is triggered	Lost connection

## D.3. Installation location and operating principle

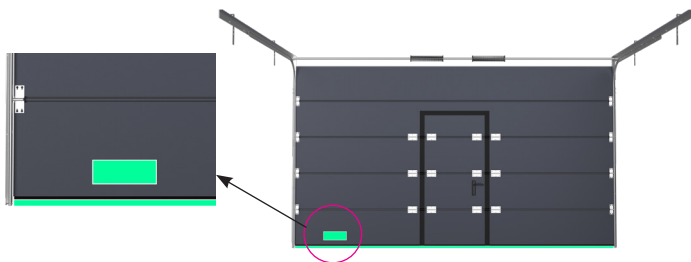

The device can detect in real time whether the door is pressed against an object to ensure safety during door operation.

If it detects that the door/gate is pressing against an object, the safety system will immediately stop or reverse to avoid injury or damage.

## IV. Installation and Configuration

### 4.1 Tools

For fast and safe installation of FRV, the following tools are recommended:



Pistol drill



Tape measure



Screwdriver



Pencil

### 4.2 Installation Steps and Operating Instructions

4.2.1 Before installation, first perform a coding test to ensure the product functions and also bring convenience of coding procedure after installation.

-- Step Instructions:



#### Step A

Open the upper cover, use a screwdriver to open the FRV shell, connect 12-24V and FLA/12-24V or FLA/AC 220V to the motor port according to the manual 3.4



## Step B



Find the  button on the device and press it for 3 seconds and then release it. All peripheral lights will light up in white, indicating that the device has entered the pairing mode.



Press and hold the  button of the wireless security device you are pairing with until all peripheral lights of the FRV flash twice quickly, and the corresponding wireless device indicator lights up according to the status.

## Step C

Try to trigger the wireless security device paired with, check the color of the wireless device indicator light (see 3.3 for the indicator light color), and hear the sound of the relay closing.

## Step D

Complete pairing all wireless safety devices.

## Step E

When the door/gate motor is running, FRV will wake up all the safety devices and test whether the wireless safety devices can work properly or not.

## Step F

When the door/gate motor stops, the FRV will put all safety devices into sleep mode. At this time, no safety devices will respond if triggered (except for wicket door and slack rope switch).

## 4.2.2 FRV installation

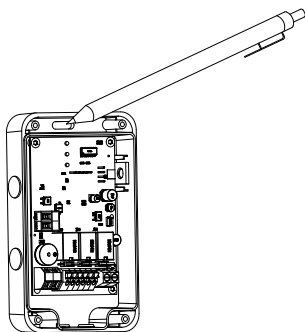

1. Make the arrow pointing direction to left, use the mounting bracket to mark right position for drilling holes.

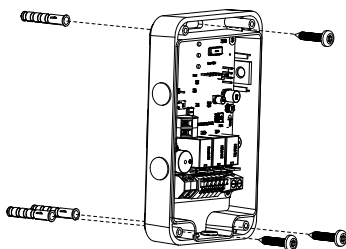

2. Put the expansion screw into the hole and secure it with the screw.

## 4.3 FRV test with door operation

Complete the wiring connection between the FRV and the door/gate motor port according to 3.4 of the manual.

During the door closing process, trigger the safety device to check whether the door/gate motor reverses or stops, and whether the FRV light indicates or not.



# V. Troubleshooting

## 5.1 FRV alarm status

When the FRV is in use, if the buzzer beeps once per second for 1 minute, it means that one of the paired safety devices has been triggered for too long. Please check the corresponding indicator light status displayed on the FRV (refer to 3.3 for the indicator light status) to check whether the corresponding device has been triggered. To ensure the battery life, do not trigger the safety device for a long time.

## 5.2 Troubleshooting of low battery on device

When FRV is in use, the indicator light of the paired wireless device lights up in cyan, which means that the battery of the wireless device is low. Please replace the battery with a new one as soon as possible.

## 5.3 Troubleshooting of abnormal device trigger status

When the FRV is in use, the indicator light of the paired wireless device lights up in red, indicating that the wireless device is triggered. Please check the installation status of the corresponding device to see if there is any damage or abnormal function of the device. Replace the device if necessary.

## 5.4 Troubleshooting of device disconnection status

When the FRV is in use, if the paired wireless device indicator light turns white, it means the wireless device is disconnected. Please check whether the device battery is powered normally or replace the battery of the corresponding device. Please check whether the device is damaged or the wireless device antenna is abnormal, and try to straighten the antenna.

## VI. Appendix

### 6.1 Packing List

Description	Qty
FRV	1
M4*20mm screw	4

### 6.2 Actual Product Dimensions

Unit of Length: mm

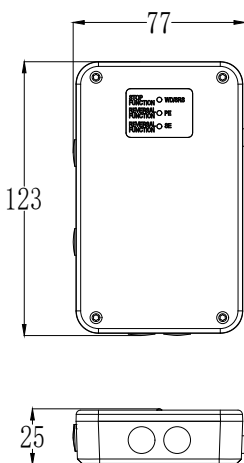

Instruction of coding with safety devices

