

# Installation Instruction User Guides

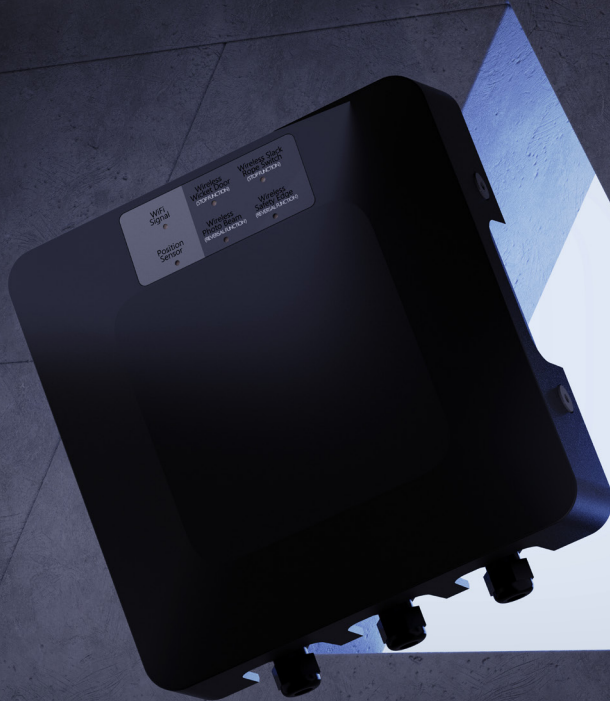

## F-BOX

Receiver for wireless safety system  
Receiver for smart Wifi remote control



# I. Description

## 1.1 Overview

The F-BOX is with a built-in WiFi module to allow the communication with a wireless position sensor for all sectional garage/industrial door control by “F-linX” APP through smartphones. The F-BOX is able to wired-free to communicate with all safety devices that connecting with a sectional door/tilting door/sliding gate, such as wireless safety edge, wireless wicket door switch, wireless slack rope switch and wireless photo beam. Linked with F-linX APP and working with Safety Center system to track all information about safety and security of the door and gates.

## 1.2 Features and Advantages

**Built-in WiFi module:** F-BOX has a built-in WiFi module, which enables it to easily connect to the Internet and realize remote control and monitoring functions.

**Security Center Link:** By linking with the "Security Center" in the "F-linX" APP, F-BOX can track all security information related to doors and gates in real time.

By the intelligent security management system, prompt detection and protection from potential security risks are provided and guaranteed.

## 1.3 Use scenarios and functions

With F-BOX, it can enhance the functions of garage door openers, industrial door drives, and sliding gate motors, and realize intelligent upgrades to the IoT and wireless safety edges.

It can also realize the management of wireless photo beam, wireless wicket door, position sensor, wireless safety edge and slack rope switch. Provide the detailed analysis report and Push-Message by Security Center.

# II. Features and Technical Data

## 2.1 F-BOX Features

- 4 relay outlets with selectable operating mode. Can behave like a safety contact for reversal function or stop function
- 3 relay outlets with OP/STP/CL contact
- 1 relay outlet with PB (open-stop-close) contact
- Low voltage port for flash light contact with 12-24V, high voltage port for flash light contact with 120- 230V
- Indicator LED lights for the status of WiFi position sensor and safety sensors
- Built-in trio frequency module for anti-interference
- Fast code buttons for wireless safety sensors and position sensor

## 2.2 F-BOX Technical Data

Model	F-BOX
Radio technology	Trio-Frequency technology
Frequency	Multi from 409.025 MHz – 458.4 MHz
Signal modulation	FSK
Signal range	20 meters
Power supply	12-24 V AC/DC
Number of relays	8 relays
Built-in WiFi format	2.4G
F-linX	Available
NC/NO	Adjustable
IP grade	IP 65
Operating temperature	-20°C - + 60°C

## III. Product Composition Display

### 3.1 F-BOX Product Composition Display

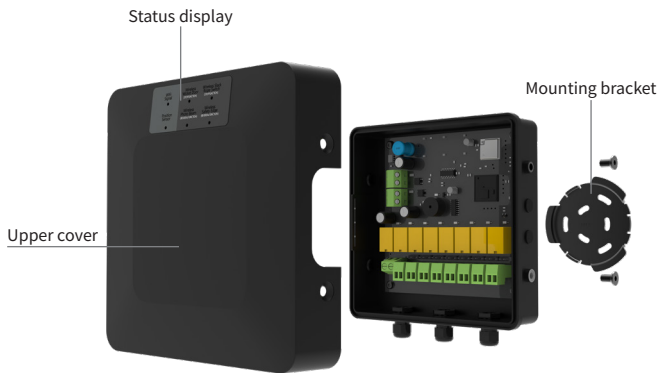

## 3.2 Compatible safety accessories

3.2.1 As a safety receiver, F-BOX is capable of pairing with the following devices:

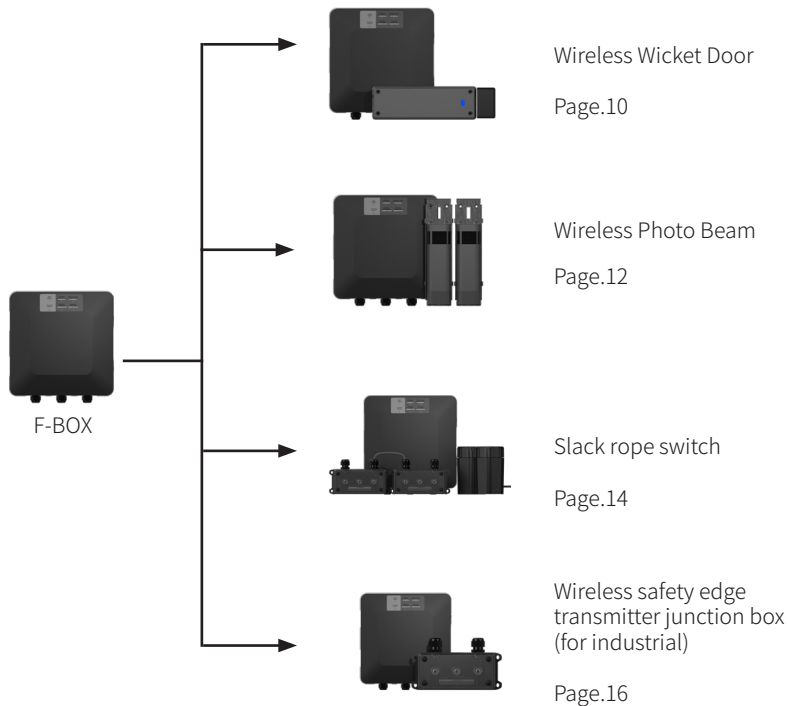

3.2.2 As a universal controller for open stop close or any standard lifting garage door, F-BOX is capable of pairing with a position sensor.

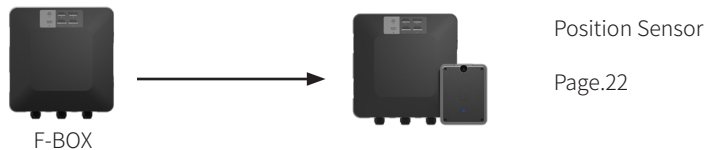



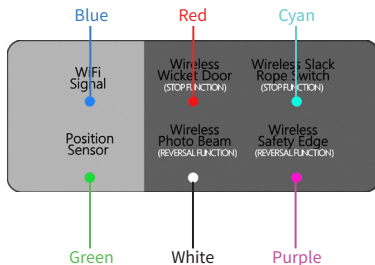

### 3.3 Status display LED description

By figure bellow for example of LED color to show working status of all wireless safety devices.



Different LED colors correspond to wireless safety device status:

LED Color \ Device Name	Green 	Red 	Cyan 	Purple 	White 
Wireless Wicket Door	Working fine	Function triggered	Low battery	Low battery and is triggered	Lost connection
Wireless Slack Rope Switch	Working fine	Function triggered	Low battery	Low battery and is triggered	Lost connection
Position Sensor	Device is connected and working	\	Low battery	\	Lost connection
Wireless Photo Beam	Working fine	Function triggered	Low battery	Low battery and is triggered	Lost connection
Wireless Safety Edge	Working fine	Function triggered	Low battery	Low battery and is triggered	Lost connection

#### WiFi Signal

When powered on but not connected to the network, the WiFi signal LED will light up. After the network is successfully configured, the WiFi signal LED will remain on.

## 3.4 Configuration/pairing of F-BOX and wireless security accessories

### A. F-BOX + transmitter for wicket door (F-WICKET)

Once the F-BOX has successfully paired with transmitter for wicket door (the indicator light solid on), wire F-BOX SD port to motor's pedestrian door port.





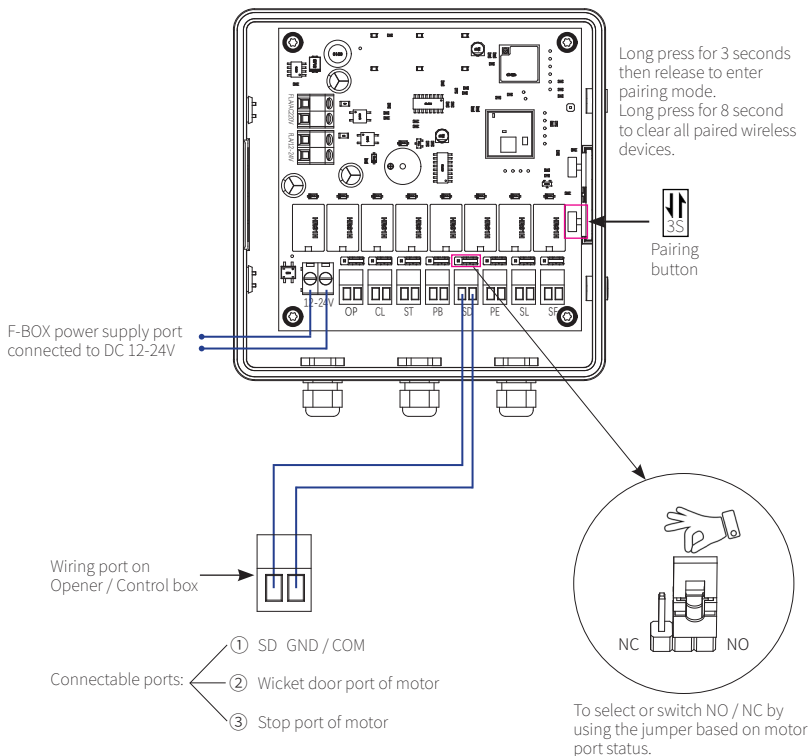

#### A.1. Wiring diagram

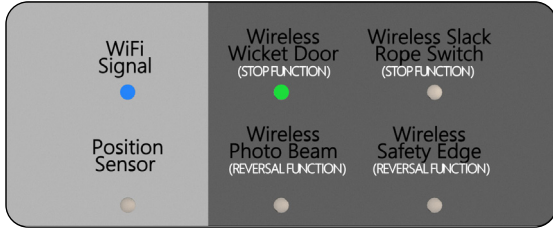

## A.2. Corresponding indicator light status description



LED Color \ Device Name	Green 	Red 	Cyan 	Purple 	White 
Wireless Wicket Door	Working fine	Function triggered	Low battery	Low battery and is triggered	Lost connection

## A.3. Installation location and operating principle

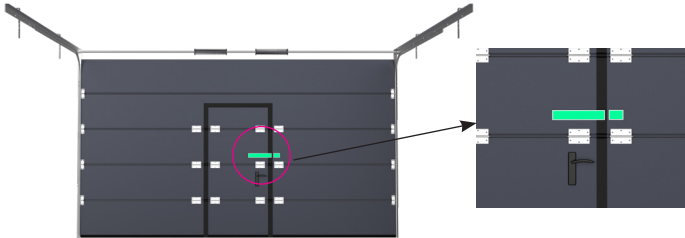

In order to ensure that the door will not be damaged when the door/gate is running, it is necessary to detect the status of the door (open or closed):

When the wicket door is closed, the wireless wicket door device is not triggered and the full door can operate.

When the wicket door is opened, the wireless wicket door device is triggered and the full door cannot be operated to avoid any damage to the full door.



## B. F-BOX + wireless photo beam (F-BEAM)

Once the F-BOX has successfully paired with wireless photo beam (the indicator light solid on), wire F-BOX PE port to motor's PE port.



### B.1 Wiring diagram

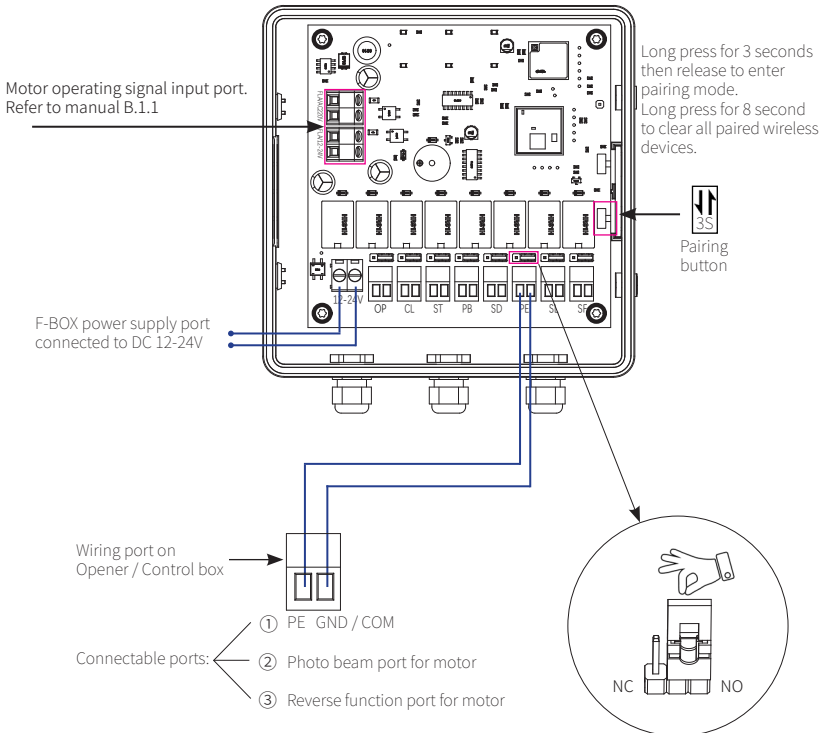

To select or switch NO / NC by using the jumper based on motor port status.

## B.1.1 Operating signal input wiring

**Note:**  
Be sure to connect the operating signal port of F-BOX to the relative port of motor before you pair F-BOX with a wireless photo beam or a wireless safety edge. Otherwise, could cause functional failure.

### 1. Motor operating signal: flash light / warning light

Motor AC 110~220V flash light or warning light port



Motor DC 12~24V flash light or warning light port

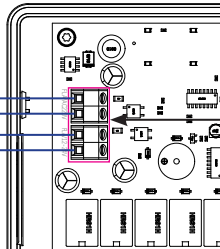

**Note:** Ensure that the indicator light is flashing during motor operating

### 2. Motor operating signal: relay output port or AUTO TEST port

Relay output port wiring diagram 1:

DC12-24V GND/COM NO COM NC

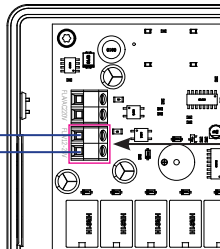
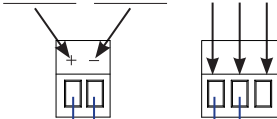

**Note:** The relay output wiring requires to enable the warning light function. (simulating the working state of warning light.).

### Relay output port wiring diagram 2:

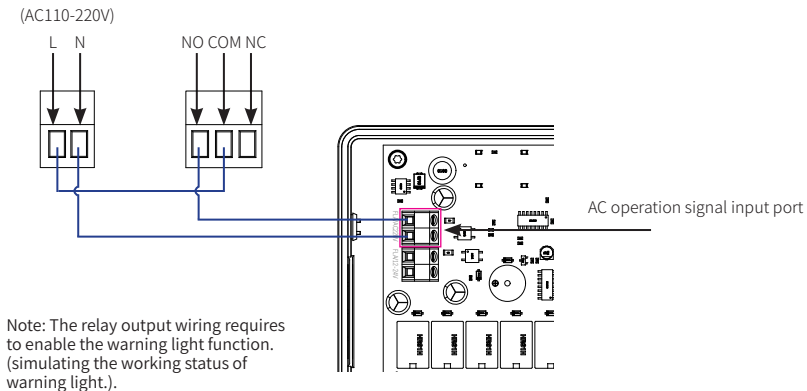

### AUTO TEST port

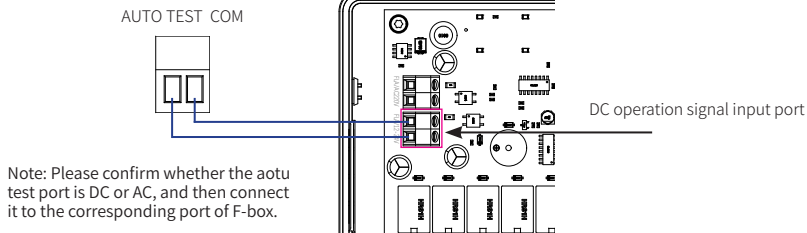

### 3. Motor operating signal: motor power supply signal

Note: Please perform wiring under the guidance of a qualified professional.

DC motor wiring diagram:

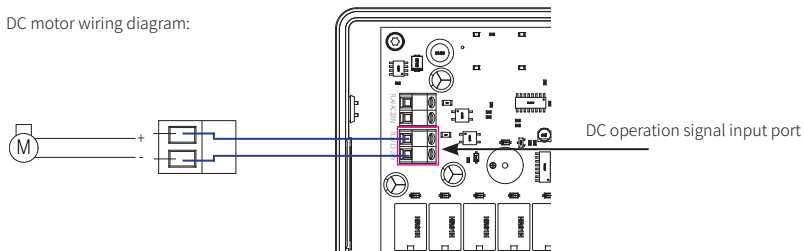

AC 220V motor wiring diagram  
(Not compatible with AC 380V motors)

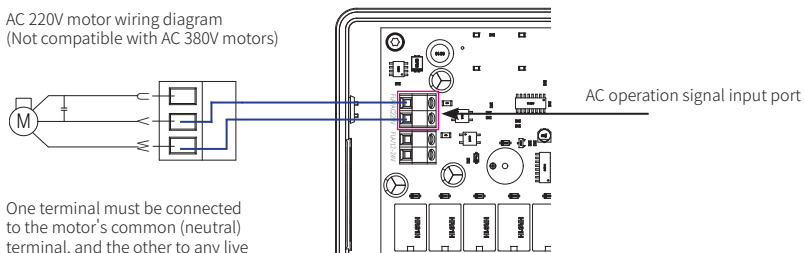

One terminal must be connected to the motor's common (neutral) terminal, and the other to any live wire of the motor.

Note: Do not connect the two live wires of the motor. Excessive voltage may cause the circuit board to overheat and be damaged.

## B.2. Corresponding indicator light status description

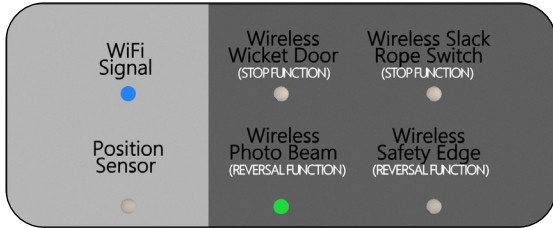

LED Color \ Device Name	Green	Red	Cyan	Purple	White
Wireless Photo Beam	Working fine	Function triggered	Low battery	Low battery and is triggered	Lost connection

## B.3. Installation location and operating principle

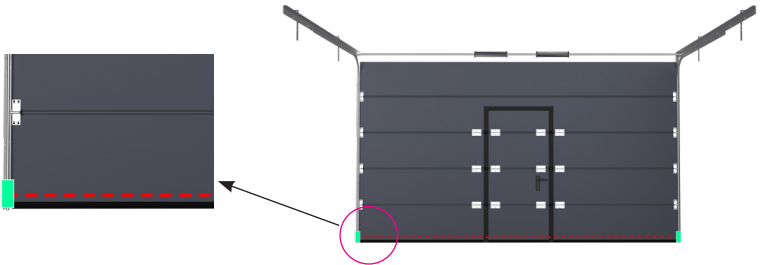

During the door closing process, the device can monitor in real time whether someone passes through the door to ensure safety during door operation. When it detect the obstacle pass through, the door will automatically stop and reverse to the open limit position.

## C. F-BOX + slack rope switch (F-CORD-2)

Once the F-BOX has successfully paired with slack rope switch (the indicator light solid on), wire F-BOX SL port to motor's SL port.

### C.1. Wiring diagram

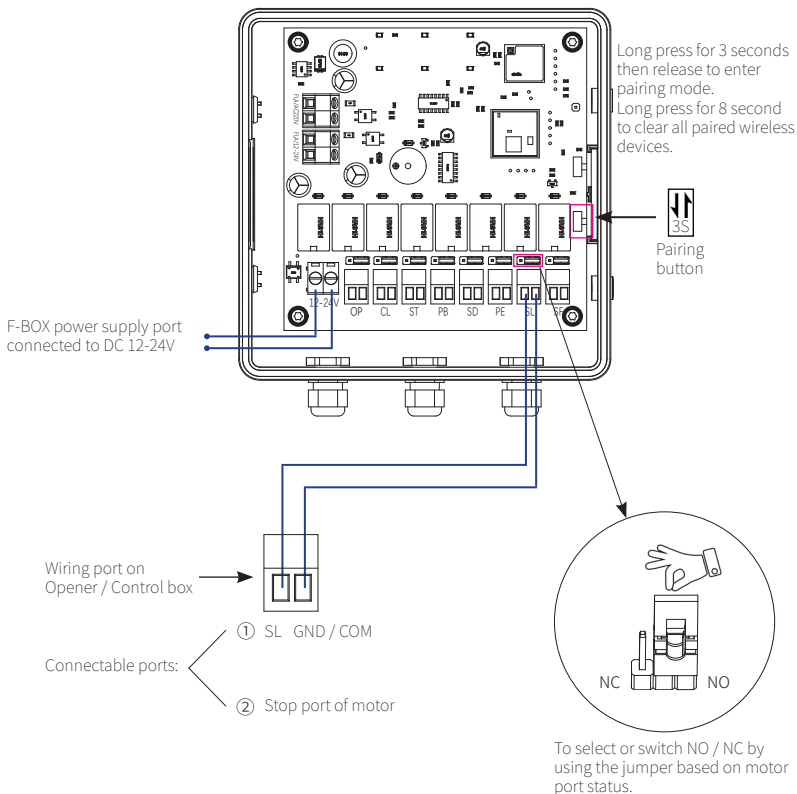

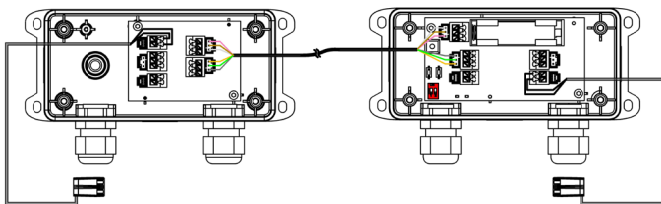



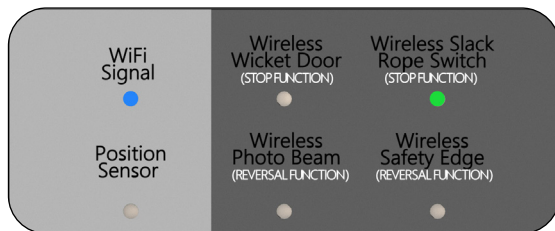

For detailed information on wiring the Slack Rope Switch, please refer to the SE-TX 03 Safety Edge Transmitter Junction Box Kit Instruction Manual.

## C.2. Corresponding indicator light status description



LED Color	Green	Red	Cyan	Purple	White
Device Name					
Wireless Slack Rope Switch	Working fine	Function triggered	Low battery	Low battery and is triggered	Lost connection

### C.3. Installation location and operating principle

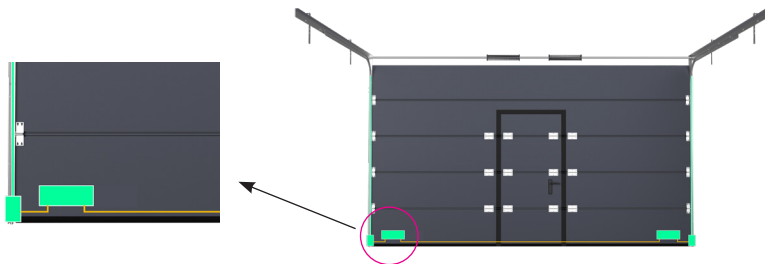

In order to ensure the safe operation of the door, it is necessary to detect whether the rope/cable of the door is loose:

If the wire rope/cable becomes loose, the safety system will give an alarm to take corresponding measures for safety.



## D. F-BOX + industrial safety edge transmitter (F-EDGE 02)

Once the F-BOX has successfully paired with safety edge transmitter (the indicator light solid on), wire F-BOX SF port to motor's SF port.



### D.1. Wiring diagram

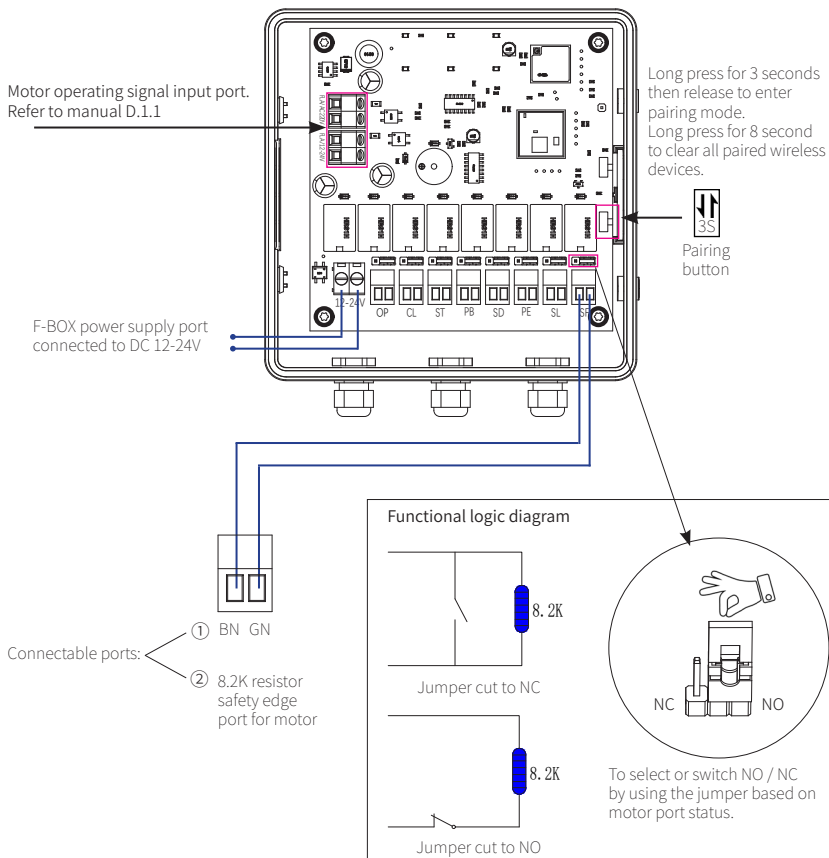

## D.1.1 Operating signal input wiring

**Note:**  
Be sure to connect the operating signal port of F-BOX to the relative port of motor before you pair F-BOX with a wireless photo beam or a wireless safety edge. Otherwise, could cause functional failure.

### 1. Motor operating signal: flash light / warning light

Motor AC 110~220V flash light or warning light port



Motor DC 12~24V flash light or warning light port

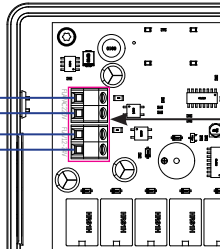

FLA/AC220V or FLA/12V-24V alternative depend on motor port supported.

**Note:** Ensure that the indicator light is flashing during motor operating

### 2. Motor operating signal: relay output port or AUTO TEST port

Relay output port wiring diagram 1:

DC12-24V GND/COM NO COM NC

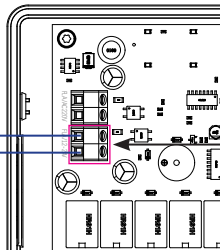
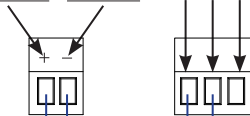

DC operation signal input port

**Note:** The relay output wiring requires to enable the warning light function. (simulating the working state of warning light.).

### Relay output port wiring diagram 2:

(AC110-220V)

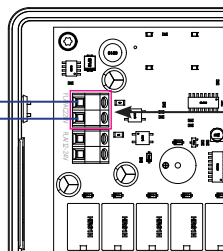
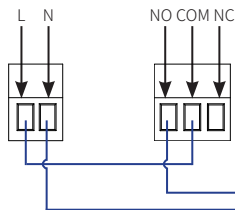

AC operation signal input port

Note: The relay output wiring requires to enable the warning light function. (simulating the working status of warning light.).

### AUTO TEST port

AUTO TEST COM

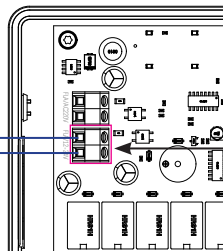

DC operation signal input port

Note: Please confirm whether the auto test port is DC or AC, and then connect it to the corresponding port of F-box.

### 3. Motor operating signal: motor power supply signal

Note: Please perform wiring under the guidance of a qualified professional.

DC motor wiring diagram:

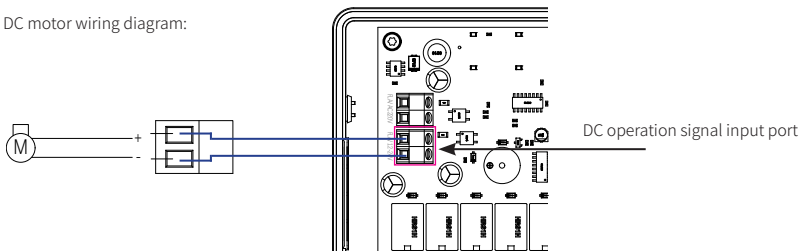

AC 220V motor wiring diagram  
(Not compatible with AC 380V motors)

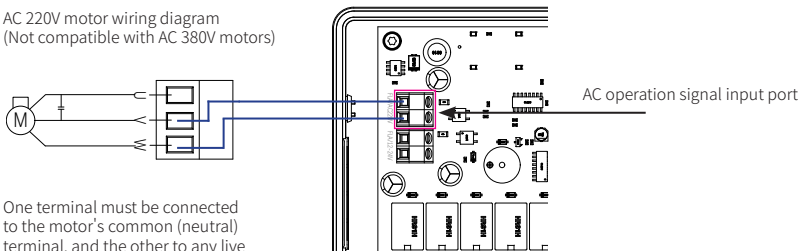

One terminal must be connected to the motor's common (neutral) terminal, and the other to any live wire of the motor.

Note: Do not connect the two live wires of the motor. Excessive voltage may cause the circuit board to overheat and be damaged.

## D.2. Corresponding indicator light status description

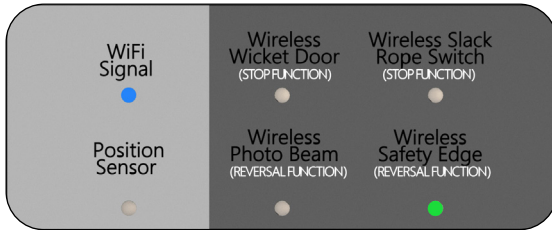

LED Color	Green	Red	Cyan	Purple	White
Device Name					
Wireless Safety Edge	Working fine	Function triggered	Low battery	Low battery and is triggered	Lost connection

## D.3. Installation location and operating principle

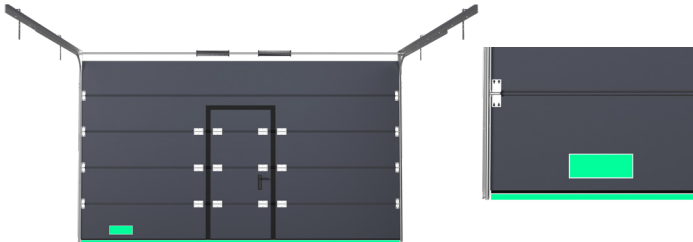

The device can detect in real time whether the door is pressed against an object to ensure safety during door operation.

If it detects that the door/gate is pressing against an object, the safety system will immediately stop or reverse to avoid injury or damage.

## IV. Position Sensor Description

### 4.1 Position Sensor Technical Data

Model	WTS
Radio technology	Trio-Frequency technology
Frequency	Multi from 409.025 MHz – 458.4 MHz
Signal modulation	FSK
Signal range	20 meters
Power supply	3V DC (2 x1.5V lithium battery)
Battery capacity	500 mAh
Operating consumption	4.5 ma
Standby consumption	18 uA
IP grade	IP 65
Operating temperature	-20°C - + 60°C

### 4.2 Position Sensor Features

- **Wireless Communication:**

The system utilizes a Wi-Fi controller(F-BOX) that communicates wireless with a waterproof wireless tilt sensor.

- **Work with F-linX App:**

The system is controlled through the "F-linX" app, which is available for both iOS and Android operating systems.

- **Six-axis Gyroscope:**

The tilt position sensor in the system is equipped with a six-axis gyroscope.

This technology allows the sensor to accurately detect and learn the position of the garage door, ensuring precise control and monitoring.

- **Universal Compatibility:**

The F-BOX & Tilt position sensor kit is designed to be a universal smart control system that can be used with various types of garage doors.

This means it can be easily integrated into most garage setups, regardless of the door types(normally used for tilting or sectional doors), making it a versatile solution for smart home automation.

### 4.3 Position Sensor Product Composition Display



### 4.4 Position Sensor Dimensions

Unit of Length: mm

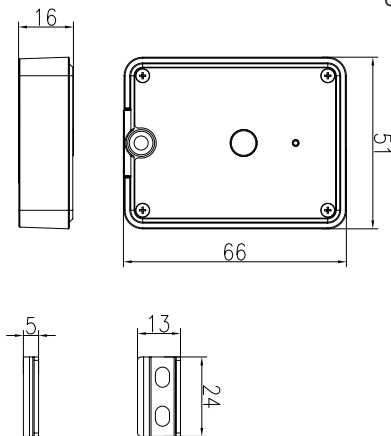

## 4.5. F-BOX + Position Sensor (F-BOX-TILT)

**NOTE:**  
Before wiring, please confirm which type of port the motor or control box is.

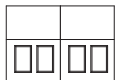

OP CL ST GND / COM



PB GND / COM

### 4.5.1. PB port wiring diagram

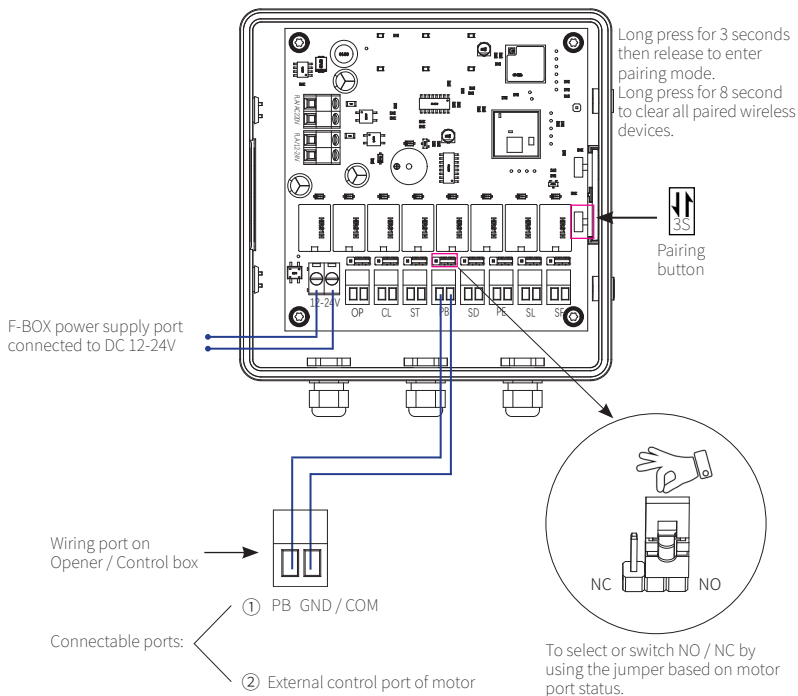



#### 4.5.2. O/S/C wiring diagram

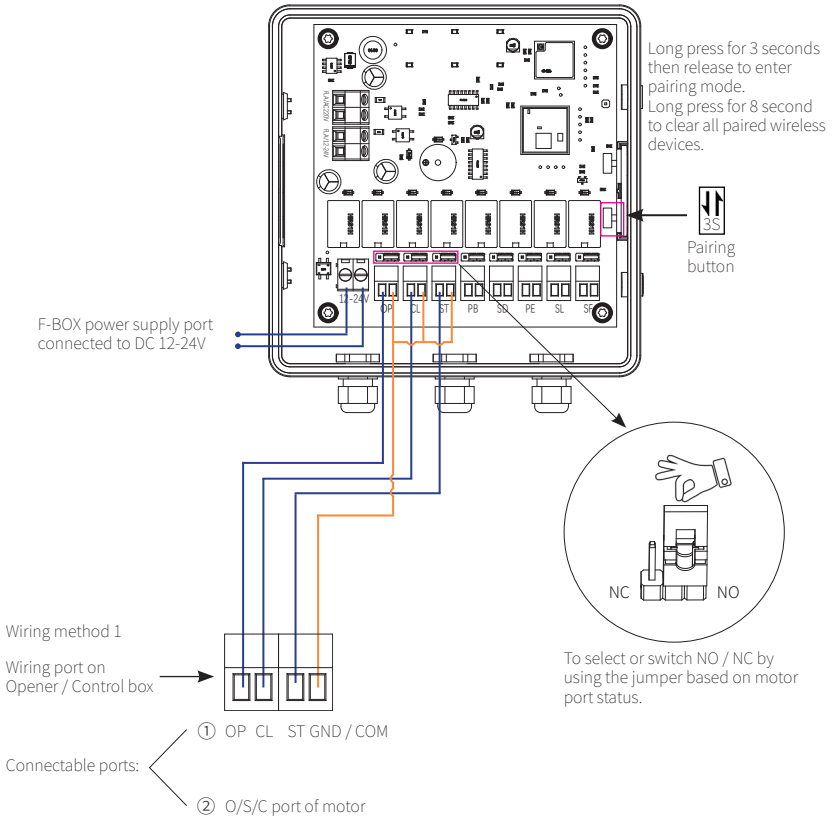

## 4.6 Position Sensor Installation Steps and Operating Instructions

4.6.1 Before installation, first perform a coding test to ensure the product functions and also bring convenience of coding procedure after installation.



### Step A

Open the housing assembly, use a screwdriver to open the position sensor housing, and install the adapted 2032 3V battery.



### Step B

To pair with the F-Box, press and hold the coding button  on F-BOX for 3 seconds and then release, then enter the coding mode. The LED indicators of the panel (except the WiFi light) will turn on bright white.

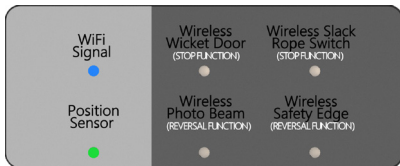

### Step C

Short press the position sensor coding button, check that the red light of the Sensor is on, then release, check that all the indicator lights of the F-Box (except the WiFi light) flash twice quickly, the buzzer beeps twice quickly, and check that the Position sensor indicator light is on. After the test is completed, lock the upper cover according to 4.2.1 A steps.

#### 4.6.2 Position Sensor Installation

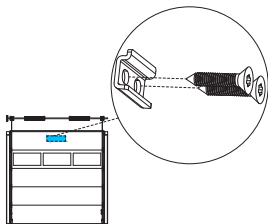

1. Use screws to install the bracket on the door in the blue area in the picture below.

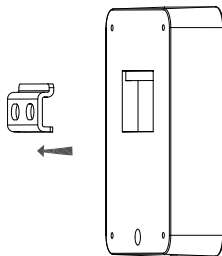

2. Clamp the Position Sensor onto the mounting bracket.

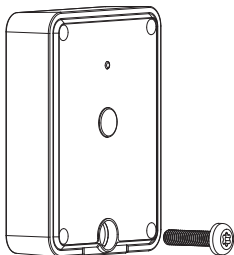

3. Use screws to fix the Position Sensor to the door.

### 4.6.3 Position Sensor Test with Door Operation

#### WARNING

If you do not follow the following settings, the door position on the APP will be reversed or abnormal.

#### Sensor position calibration

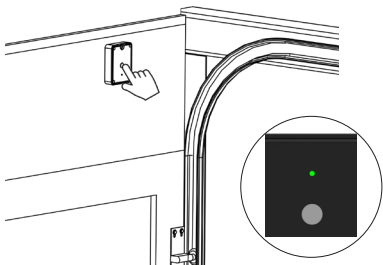

1. Completely close the door and press and hold the position sensor code button until the red LED light turns green, indicating that the sensor position has been recorded.

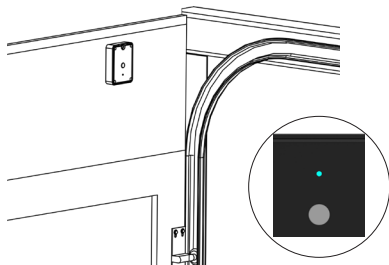

2. When the door is running, the sensor LED flashes blue and then turn off.

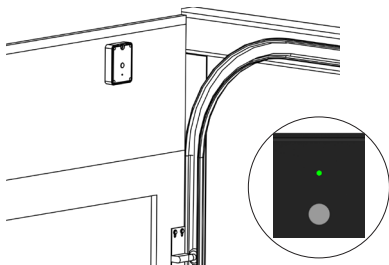

3. When the door is not at the close limit position but stops, the green LED of the sensor lights up for one second and then turn off.

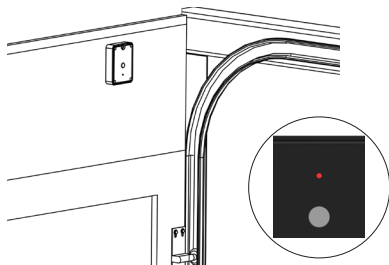

4. When the door is completely closed, the red LED of the sensor lights up for one second and then turn off.

## V. Installation and Configuration

### 5.1 Tools

For fast and safe installation of F-Box, the following tools are recommended:



Pistol drill



Tape measure



Screwdriver



Pencil

### 5.2 Installation Steps and Operating Instructions

5.2.1 Before installation, first perform a coding test to ensure the product functions and also bring convenience of coding procedure after installation.

-- Step Instructions:



Step A

Open the upper cover, use a screwdriver to open the F-Box shell, connect 12-24V and FLA/12-24V or FLA/AC 220V to the motor port according to the manual 3.2, and observe that the WiFi Signal indicator lights up.



## Step B



Find the pairing button  on the device and press it for 3 seconds and then release it. All peripheral lights (except the WiFi signal light) will light up in white and the buzzer will sound a short beep, indicating that the device has entered the pairing mode.



Press and hold the pairing button  of the wireless security device you are pairing with until all peripheral lights of the F-Box (except the WiFi signal light) flash twice quickly, the buzzer will beep twice quickly, and the corresponding wireless device indicator lights up according to the status.

Support pairable devices:

- Position Sensor
- Wireless Wicket Door
- Wireless Slack Rope
- Wireless Safety Edge
- Wireless Photo Beam

(For detailed device pairing information, scan the QR code on the last page of this manual)

## Step C

Try to trigger the wireless security device paired with, check the color of the wireless device indicator light (see 3.3 for the indicator light color), and hear the sound of the relay closing, which means the pairing is successful and device is working correctly.

## Step D

Complete pairing all wireless safety devices.

### Step E

When the door /gate motor is running, F-Box will wake up all the safety devices and test whether the wireless safety devices can work properly or not.

### Step F

When the door/gate motor stops, the F-Box will put all safety devices into sleep mode. At this time, no safety devices will respond if triggered (except for wicket door and slack rope switch).

#### 5.2.2 F-Box installation

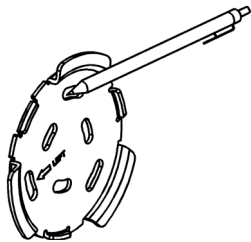

1. Make the arrow pointing direction to left, use the mounting bracket to mark right position for drilling holes.

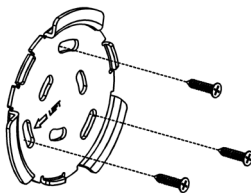

2. Put expansion screws into holes, install the metal bracket and secure it with screws.

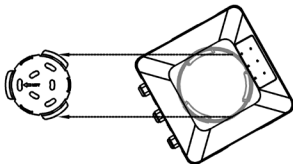

3. Place the F-Box into the mounting bracket at a right angle and rotate it until it is securely fixed.

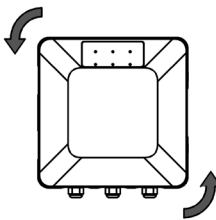

### 5.3 F-BOX test with door operation

Complete the wiring connection between the F-Box and the door/gate motor port according to 3.4&3.5 of the manual.

During the door closing process, trigger the safety device to check whether the door/gate motor reverses or stops, and whether the F-Box light indicates or not.



## **VI. Troubleshooting**

### **6.1 F-BOX alarm status**

When the F-BOX is in use, if the buzzer beeps once per second for 1 minute, it means that one of the paired safety devices has been triggered for too long. Please check the corresponding indicator light status displayed on the F-Box (refer to 3.3 for the indicator light status) to check whether the corresponding device has been triggered. To ensure the battery life, do not trigger the safety device for a long time.

### **6.2 Troubleshooting of low battery on device**

When F-BOX is in use, the indicator light of the paired wireless device lights up in cyan, which means that the battery of the wireless device is low. Please replace the battery with a new one as soon as possible.

### **6.3 Troubleshooting of abnormal device trigger status**

When the F-BOX is in use, the indicator light of the paired wireless device lights up in red, indicating that the wireless device is triggered. Please check the installation status of the corresponding device to see if there is any damage or abnormal function of the device. Replace the device if necessary.

### **6.4 Troubleshooting of device disconnection status**

When the F-BOX is in use, if the paired wireless device indicator light turns white, it means the wireless device is disconnected. Please check whether the device battery is powered normally or replace the battery of the corresponding device. Please check whether the device is damaged or the wireless device antenna is abnormal, and try to straighten the antenna.

## VII. Appendix

### 7.1 Packing List

Description	Qty
F-BOX	1
Mounting bracket	1
Position Sensor	Optional
Position Sensor Mounting Bracket	1
M4*20mm screw	7

### 7.2 Actual Product Dimensions

Unit of Length: mm

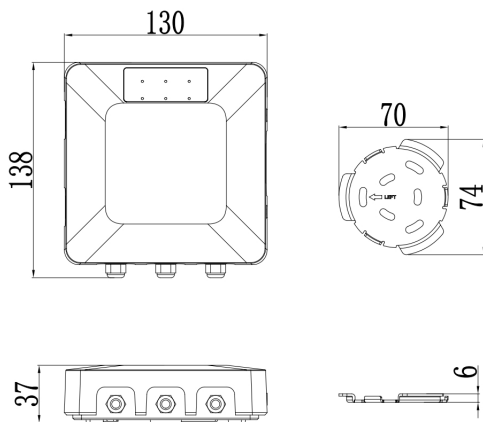

## VIII. F-linx APP Description

Download the app and follow the prompts to complete the F-BOX network configuration.



With the Fbox and the security center of the F-Linx app, you can monitor and manage your wireless security devices anytime and anywhere, ensuring the safety of your doors without worry and you can also control it through the app.

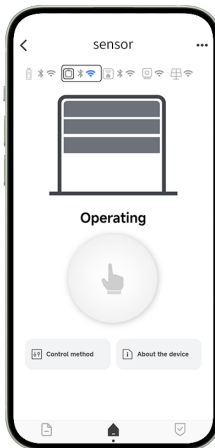
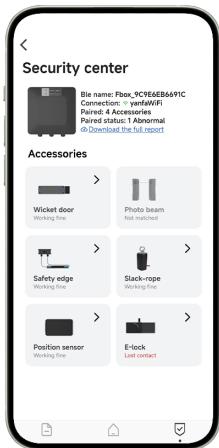

Instruction of coding with safety devices

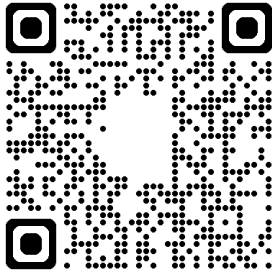

Instruction of WiFi network connection

